

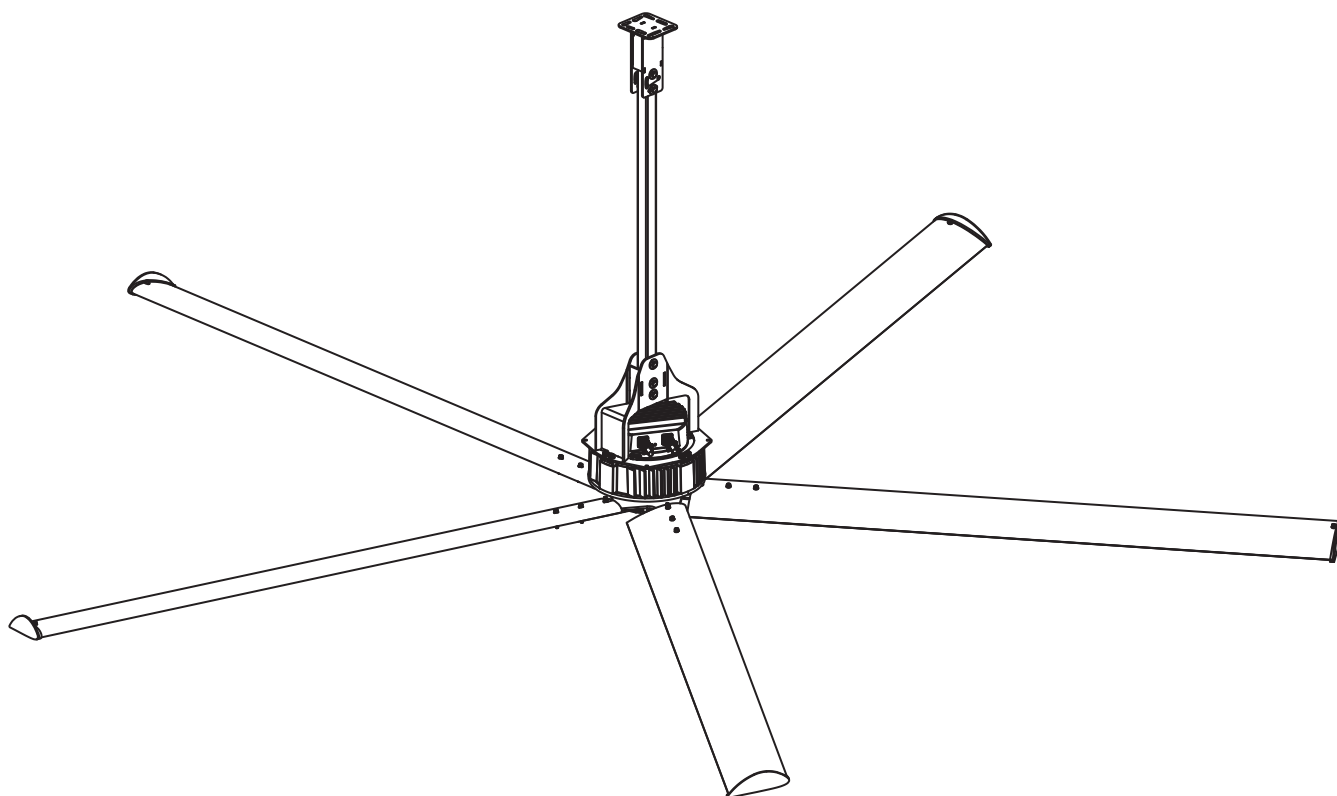

NORDIK HVLS SUPER BLADET

UK
CA C E



1 CONTENTS

1	INTRODUCTION	3
1.1	General warnings	3
1.2	Conventions used in this manual	3
1.3	Glossary and pictograms	4
2	GENERAL INFORMATION	9
2.1	Application	9
2.2	Versions	9
2.3	Machine identity data and data plates	10
2.4	Manufacturer's identity details	10
2.5	Declarations	11
2.6	Description of the parts	11
3	TRANSPORTATION AND HANDLING	14
3.1	Handling	14
3.2	Operative instructions	14
3.3	Warranty	15
3.4	Storage and landing-up	15
4	ASSEMBLY	15
5	INSTALLATION	16
5.1	Preliminary operations	16
5.2	Positioning	16
5.3	Optimum installation conditions	16
5.4	Tightening torque	17
5.5	Tie bars	17
5.6	Noise emissions	17
5.7	Cleaning	17
5.8	Electrical connection	17
6	OPERATION	18
6.1	Preliminary operations	18
6.2	Starting for the first time	18
6.3	Emergency stoppage	18
6.4	Starting	18
7	MAINTENANCE	19
7.1	Routine maintenance	19
7.2	Periodic checking	19
7.3	Extraordinary maintenance	20
8	TECHNICAL CHARACTERISTICS	20
8.1	Technical data	20
8.2	Spare parts list	21
9	TROUBLESHOOTING	22
	ATTACHMENT 1 ASSEMBLY INSTRUCTIONS	23
	ATTACHMENT 2 ELECTRIC CONNECTION	52

1 INTRODUCTION

1.1 General warnings

- Make sure you have a complete copy of this manual and the enclosed Assembly Instructions available. Read both documents fully and make sure you understand them adequately before proceeding with subsequent steps. If you have any doubt about a task to be carried out, apply the criterion of maximum personal and collective safety. Immediately interrupt your work, make everything done so far in complete safety, and ask for adequate instructions, if necessary, from the manufacturer as well.
- Check the integrity of the equipment when opening the packaging. Pay particular attention to damage to or deformation of mechanical parts, which may result in breakage and/or malfunctions when in use. If any of these are found, do not connect the machine to the power supply. Carry out these checks every time before use.
- Before connecting the machine to the power supply, check that the indications on the data plate correspond to the electricity supply. The data plate is located on the electronic motor (see par. 1.9).
- Each and every person that may come into contact in any way with the product marketed by VORTICE S.p.A., and described here, must be adequately informed by the purchaser of about use, risks, dangers and safety procedures, in the ways provided for by law and as described below in this document.

Conform to safety norms indicated for electrical equipment, and especially:

- Conform to the assembly and installation instructions for the equipment.
- Do not put items on top of the ceiling fan, and do not hang anything from the ceiling fan's blades.
- Do not touch the ceiling fan when it is running, or immediately after it has stopped. Remember that the motor could be hot.
- Never immerse the equipment in water or any other liquid, and do not use water, especially pressurised, for washing or cleaning the fan or its parts. This equipment is not designed to be impermeable to water. Do not touch the equipment if it gets wet by accident. Immediately disconnect the power supply by switching off the switch on the electrical panel for your system, and immediately disconnect the feeder before touching the equipment. Use suitable means to indicate that reinstating the power supply at the panel is forbidden.
- Do not touch the equipment with wet and/or damp hands.
- Do not use accessories, spare parts and/or components that are not indicated or supplied by the manufacturer
- Do not pull the power supply cable or expose it to a risk of being sheared.
- If a fault occurs and/or the equipment works badly, switch it off immediately and disconnect the power supply. Use suitable means to indicate that reinstating the power supply at the panel is forbidden. Do not attempt to open or tamper with the equipment. Contact VORTICE's technical service department.

1.2 Conventions used in this manual

The Manual is broken down into independent chapters, each of which is addressed to a specific type of operator (INSTALLER, MACHINE OPERATOR AND MAINTENANCE TECHNICIAN), for which the skills required to operate on the machine in safety have been defined.

The sequence of the chapters follows the temporal logic of the machine's lifespan.

To facilitate immediate understanding of the text terms, abbreviations and pictograms are used, the meaning of which is indicated below.

ABBREVIATION

Cap. = Chapter

Par. = Paragraph

Pag. = Page

Fig. = Figure

Tab. = Table

UNIT OF MEASUREMENT

The units of measurement used are those from the International System (SI).

Keeping this instruction manual

The instruction manual, along with the enclosed Assembly Manual, must be kept and must stay with the machine through all changes of ownership that may occur during the machine's lifespan.

Anyone who has to come into contact with the ceiling fan in any way or that is involved with using it (due to proximity of the working area, etc.) must be informed of this manual as well as the enclosed Assembly Manual, and adequately trained by the purchaser / user.

Conservation of the same must be facilitated by handling it carefully, with clean hands and avoiding putting it on dirty surfaces.

The parts must not be removed, torn or arbitrarily changed.

The manual and the enclosed assembly manual must be kept in a place protected against damp and heat, and in the immediately vicinity of the machine to which it relates.

The Manufacturer is able to provide further copies of the Instruction Manual and the enclosed Assembly Manual for the machine, if requested by the User.

Such requests should be sent to VORTICE Technical Dept. (www.vortice.com)

Recipients

This Manual and the enclosed Assembly Manual are addressed to: The Installer, Operator, and Qualified Personnel authorised to carry out maintenance tasks in the machine.

EXPOSED PERSON:	This means any person who may find themselves fully or partly within the area affected by use of the ceiling fan.
OPERATOR:	This means the person(s) tasked with installing, operating, setting, cleaning, repairing, moving or doing maintenance work on the machine.
QUALIFIED PERSONNEL QUALIFIED OPERATOR	Person(s) that has/have done a specialisation course, training etc. and that have experience of installing, commissioning, maintaining, repairing or transporting the machine.

This machine is intended for industrial use, and so professional and not general use, which means that it must be entrusted to qualified personnel that are adequately trained in using it by the purchaser, and that especially:

- Are no longer minors
- Are physically and psychologically suitable for doing particularly difficult technical tasks.
- Have been trained on the use of the personal protection equipment indicated and required.
- Are suitably instructed in using and maintaining the machine.
- Have been adjudged suitable by the employer to do the tasks assigned to them.
- Are able to understand and interpret the operator's manual and safety instructions.
- Know the emergency procedures and how to implement them.
- Have the capacity to operate this specific type of equipment.
- Are familiar with the relevant specific standards.
- Have understood the operating procedures defined by the machine's constructor.

1.3 Glossary and pictograms

This paragraph lists uncommon terms or terms whose meaning differs from the common meaning. The abbreviations used and the meaning of the pictograms used to indicate the operator's qualifications and machine status are explained below. Use of the same makes it possible to provide quick, unequivocal information required for correct use of the machine in safety.





GLOSSARY (Ann. I p. 1.1.1 Dir. 2006/42/EC)

<i>DANGER</i>	A potential source of injury or harm to one's health.
<i>DANGER ZONE</i>	Any zone inside and/or in proximity to the machine in which the presence of a person constitutes a risk to the health and safety of that person.
<i>EXPOSED PERSON</i>	Any person that finds themselves fully or partially in a danger zone
<i>OPERATOR</i>	The person(s) tasked with installing, operating, setting, cleaning, repairing, moving or doing maintenance work on the machine.
<i>RISK</i>	A combination of the probability and gravity of an injury or damage to one's health that may result in a dangerous situation.
<i>GUARD</i>	A part of the machine used specifically to ensure protection by means of a material barrier.
<i>PROTECTIVE DEVICE</i>	A device (other than a guard) that reduces a risk on its own or in association with a guard.
<i>INTENDED USE</i>	Use of the machine within the limits laid down by the Manufacturer, for which the machine is designed and built, in conformity to the information provided in the instructions for use.
<i>REASONABLY FORESEEABLE INCORRECT USE</i>	Use of the machine in a way that differs from that indicated in the instructions for use, but that may result from human behaviour that can easily be foreseen.

OTHER DEFINITIONS



- MAN-MACHINE INTERACTION:** Any situation in which an operator interacts with the machine, in any operating phase, and at any time in the life of the machine.
- OPERATOR'S QUALIFICATION :** The minimum skill level the operator must have to carry out the operation described.
- NUMBER OF OPERATORS :** Number of operators able to carry out the operation described in the best possible way, and resulting from careful analysis by the manufacturer. Therefore, use by a number of different members of staff could prevent the expected result being achieved or put the personnel involved in danger.
- MACHINE STATUS :** The machine's status includes its operating mode, such as automatic operation, jog mode control, stopping, etc., the condition of the safety devices in the machine, such as guards included, guards excluded, emergency button pushed, type of isolation from energy sources, etc
- RESIDUAL RISK :** Risks that remain, despite integrated protective measures being adopted that are integrated in the design of the machine, and despite the additional protective devices and measures adopted.
- SAFETY COMPONENT :** Component:
- Intended to provide a safety function.
 - A component that, if damaged and/or tampered with, puts the safety of the people involved in jeopardy (e.g. lifting equipment; fixed, mobile or adjustable guard, etc.; electrical, electronic, optical, pneumatic or hydraulic device that serves as, or interlocks a guard, etc.).

PICTOGRAMS RELATED TO THE OPERATOR QUALIFICATIONS

Symbol	Description
	<p>General operator: an operator without specific skills, only able to carry out simple tasks according to the instructions of qualified technicians.</p>
	<p>Lifting and handling gear operator: an operator authorised to use lifting gear and for handling materials and machines (strictly according to the manufacturer's instructions), according to the laws in force in the country in which the machine is used.</p>
	<p>Mechanical maintenance operator: a qualified technician able to operate the machine under normal conditions, to make it work in jog mode with the protective devices deactivated, and do work on the mechanical parts to effect the necessary adjustments, maintenance and repairs. Normally, they are not authorised to work on live electrical systems.</p>
	<p>Electrical maintenance operator: a qualified technician able to operate the machine under normal conditions, to make it work in jog mode with the protective devices deactivated, and do all tasks of an electrical nature involved in adjustments, maintenance and repairs. They are able to work in electrical cabinets and derivation boxes, with the power on.</p>
	<p>Manufacturer's technician: a qualified technician made available by the manufacturer to carry out complex tasks in particular situations or, in any case, as agreed with the user. The skills they possess are of a mechanical and/or electrical and/or electronic and/or software nature.</p>

PICTOGRAMS RELATED TO THE MACHINE STATUS









The pictograms enclosed in a square / rectangle, provide INFORMATION.

Symbol	Machine status
	Machine off: with the electrical and pneumatic power supplies disconnected.
	Machine running: operating in automatic mode, with mobile guards closed, related interlocking devices activated, and fixed guards closed.
	Machine on: stopped and ready to start (stand-by conditions) by activating an operating activator (e.g. control unit consensus), with mobile guards closed, safety device activated, and fixed guards closed.

SAFETY PICTOGRAMS

Pictograms contained with a triangle indicate DANGER.

Pictograms contained within a circle impose a PROHIBITION/OBLIGATION

Pictogram	Name
	High voltage danger
	Entanglement
	Dragging
	General danger
	Do not remove the safety devices
	Cleaning, oiling, greasing, repairing, or adjusting moving parts manually forbidden.
	Obligation to disconnect the power supply before starting work or repairs.
	Protective gloves obligatory
	Safety footwear obligatory

2 GENERAL INFORMATION

2.1 Application

Intended use

Ceiling fan to be installed by fixing to the ceiling, for industrial buildings

This equipment is only to be used for the purpose for which it was expressly designed. Any other use is to be considered improper and dangerous. VORTICE S.p.A. cannot be held responsible for any damage resulting from improper, erroneous or unreasonable use, or if the equipment is used with systems that do not conform to the current safety norms.

This machine must be installed where there is a need to cool large closed spaces, such as workshops or industrial departments, factory buildings, etc.

The materials used ensure reliability and durability over time, provided the machine is installed correctly and subjected to suitable maintenance by qualified personnel.



This machine is only to be used for the purpose for which it was designed: Ceiling air fan to be installed fixed to the ceiling, for industrial buildings.
All other uses are to be deemed improper and therefore dangerous.



Uses explicitly excluded

This product as a whole, including its construction components, is NOT made and therefore must absolutely NOT be used for other purposes such as, by way of example and not exhaustively:

ATMOSFERE:

- Use in atmospheric conditions even only potentially explosive
- Use in aggressive atmospheric conditions
- Use in atmospheric conditions with high salinity or humidity over 90% of that of the standard atmospheric air
- Use in places in which external suspended elements are present (for example, fibres, powders, paints, sand)

INSTALLATION:

- Use in outside environments (e.g. lean-to roofs, pergolas, trellises, temporary worksites)
- Use in places that subject the product to vibrations or oscillations (for example: ships, precarious structures, or semi-rigid composite structures such as tents, hot houses, mobile hangars)
- Precarious and temporary use.

2.2 Versions

The CEILING FAN comes in the following versions

- NORDIK HVLS SUPER BLADE 300/120" T
- NORDIK HVLS SUPER BLADE 400/160" T
- NORDIK HVLS SUPER BLADE 500/200" T
- NORDIK HVLS SUPER BLADE 600/240" T
- NORDIK HVLS SUPER BLADE 700/280" T
- NORDIK HVLS SUPER BLADE 300/120" T L
- NORDIK HVLS SUPER BLADE 400/160" T L
- NORDIK HVLS SUPER BLADE 500/200" T L
- NORDIK HVLS SUPER BLADE 600/240" T L
- NORDIK HVLS SUPER BLADE 700/280" T L
- NORDIK HVLS SUPER BLADE 700/280" S T
- NORDIK HVLS SUPER BLADE 700/280" S T L

2.3 Machine identity data and data plates

Each machine is identified by a motor plate, that contains its reference details in an indelible state. Whenever contacting the manufacturer or service centres, always quote these reference details. The position of the plate on the machine may vary from one machine to another.

2.4 Manufacturer's identity details

Manufacturer



VORTICE S.p.A.
Strada Cerca, 2
Frazione di Zoate
20067 Tribiano (Milano)
ITALY

Ph: (+39) 02 906991 www.vortice.com

2.5 Declarations

This machine was made in conformity with the pertinent European Directives applicable at the time it was put on the market

EC Declaration of Conformity

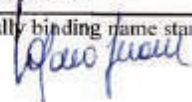
Vortice S.p.A. Strada Cerca 2, Frazione di Zoate 20067 Tribiano (MI), Italy		
UE DECLARATION OF CONFORMITY DICHIARAZIONE DI CONFORMITA' UE		
VORTICE S.p.A. declares under its own responsibility that the products: <i>dichiara sotto la propria responsabilità che i prodotti:</i> NORDIK HVLS SUPER BLADE RANGE NORDIK HVLS SUPER BLADE TUTTI I MODELLI comply with the following Directives, Standards and Regulations: <i>sono conformi alle seguenti Direttive, Norme e Regolamenti:</i>		
Directive on Machinery <i>Direttiva Macchine</i>	2006/42/EC	
Reference Standards <i>Norme di riferimento</i>	EN ISO 12100 (2010) EN 60204-1 (2006)+ A1(2009)+EC (2010)	
Low Voltage Directive <i>Direttiva Bassa Tensione</i>	LVD Directive 2014/35/EU	
Reference Standards <i>Norme di riferimento</i>	EN 60335-1(2012) EN 60335-2-80(2003)+A1(2004)+A2(2009) EN 62233 (2008)	
Electromagnetic Compatibility Directive <i>Direttiva Compatibilità Elettromagnetica</i>	EMC Directive 2014/30/EU	
Reference Standards <i>Norme di riferimento</i>	EN 55014-1 (2006)+ A1(2009)+A2(2011) EN 55014-2 (1997) + A1(2001)+A2(2008) EN 61000-3-2(2006)+ A1(2009)+A2(2009) EN 61000-3-3(2013)	
Waste Electrical & Electronic Equipment Directive : <i>Direttiva Rifiuti Apparecchiature Elettriche ed Elettroniche</i>	WEEE Directive 2012/19/EU	
Tribiano, 10/02/2020 place and date	VORTICE S.p.A. General Manager Ing. Stefano Guantieri  legally binding name stamp and signature 	

2.6 Description of the parts

Parts that make up the ceiling fan

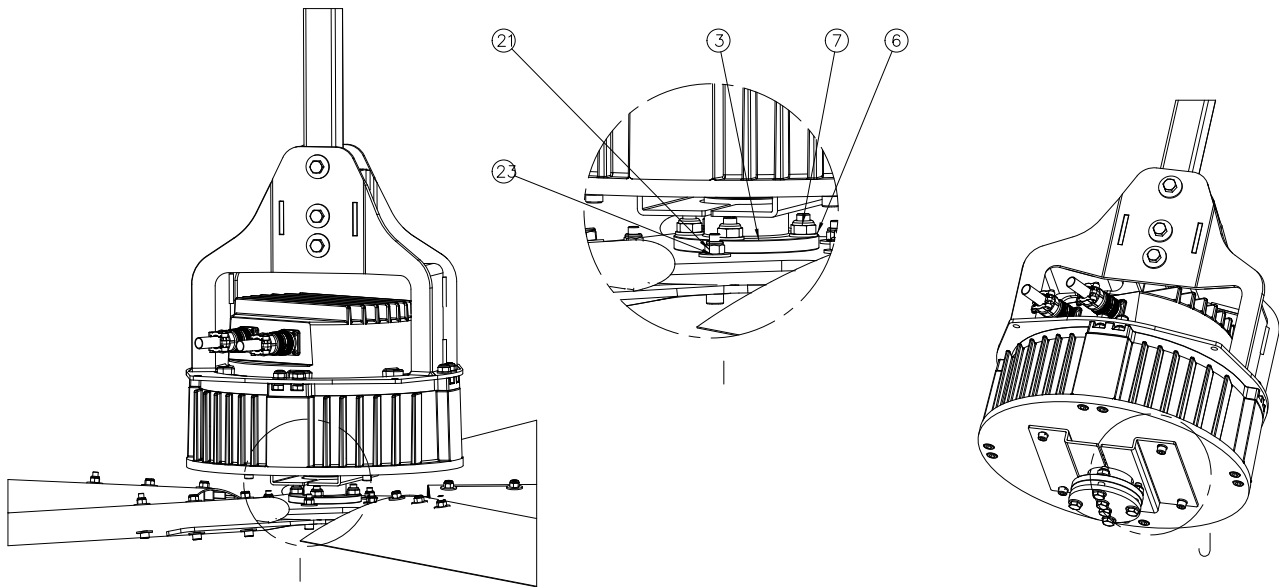

NUM.	DESCRIZIONE	Q.TA'
1	Motor rod holder	1
2	Welded rod holder	1
3	Tempered shaft hub	1
4	Fissing plate	1
5	Rod 50X50 drilled and galvanized	1
6	Washer 10.5X20 H2 galvanized UNI 6592	16
7	Self-locking nut M10 galvanized UNI 7474	12
8	Screw M10X45 TH galvanized UNI 4018	4
9	Screw 10X35 TH galvanized UNI 4018	2
10	Safety holder	2
11	Washer Grower D. 8 galvanized	4
12	Screw M8X25 TCH INOX	4
13	Washer 14X36 H2,5 galvanized UNI 6593	10
14	Screw M12X90 TH galvanized UNI 4014	5
15	Self-locking nut M12 galvanized UNI 7473	5
16	Washer Grower D.10 galvanized	2
17	Blade Support	1
18	Fan blade	5
19	Winglet	5
20	Washer 8,4X16 H6 galvanized UNI 6592	10
21	Self-locking nut M8 galvanized UNI 7473	25
22	Screw M8X60 TCEI ZN UNI 5931	15
23	Washer 8X24 H2 galvanized UNI 6593 FL	40
24	Screw M8X45 TCH galvanized UNI 5931	10
25	Reinforced spider folder + spacer	1
26	Bottom cap	1

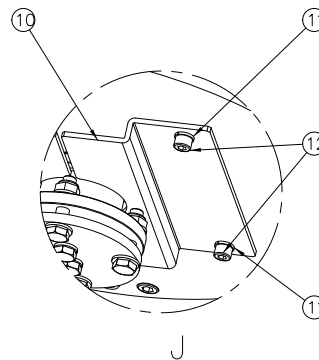

Fig. 2

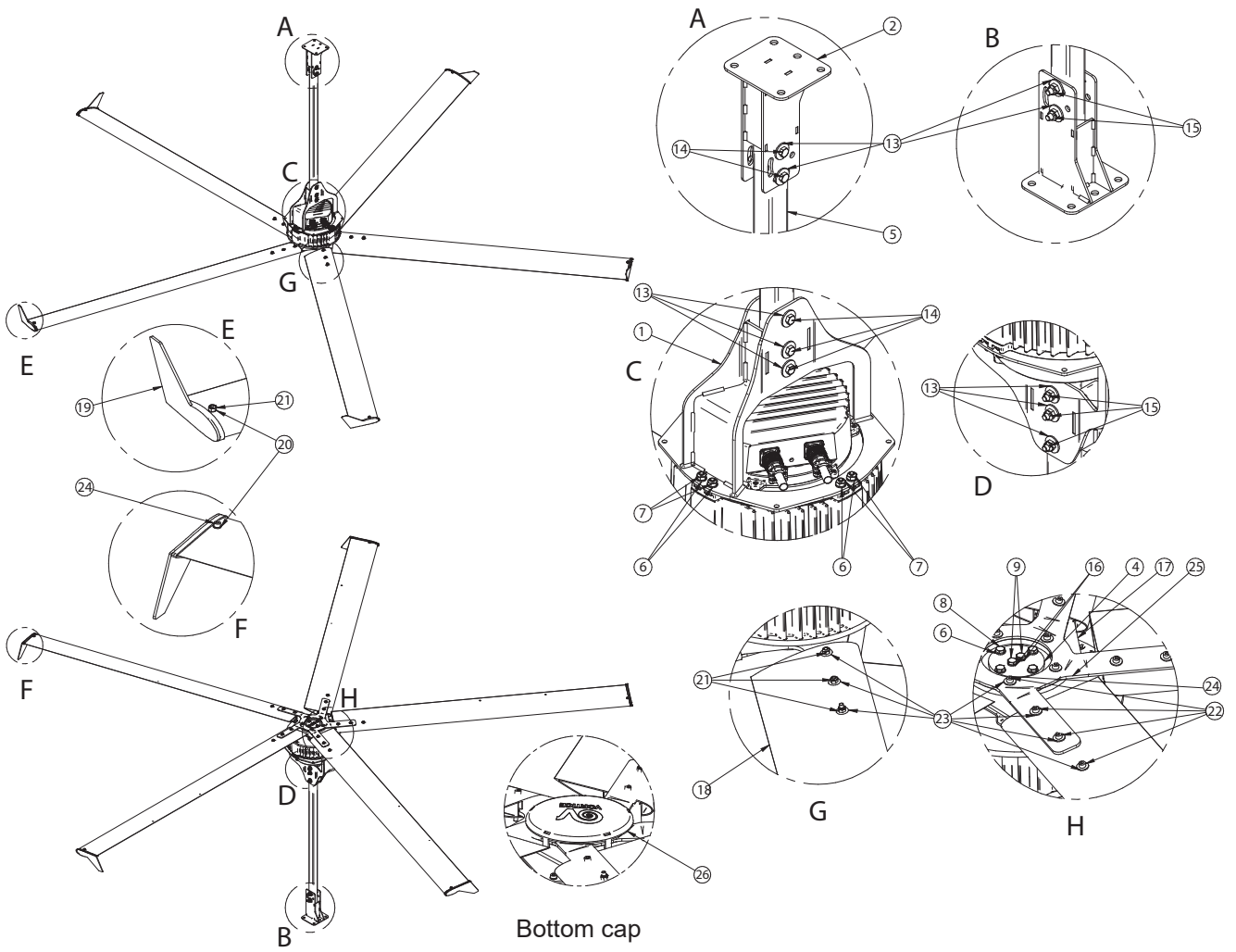

Fig. 3

3 TRANSPORTATION AND HANDLING



VORTICE S.p.A. goal is to attain maximum respect for the environment. To this end, and to facilitate the greatest efficiency possible for the end client, it avoids the use of unnecessary or excessive packaging as much as possible, in order to minimise the environmental impact. Unless the purchaser has specific needs or specific requests that are assessed in each case, the product is supplied on a timber pallet inside a cardboard box, where necessary, otherwise it is simply placed in the pallet (e.g. aluminium blades), with parts covered in protective plastic.

The packs must not be stacked.

Avoid damaging the machine's components by being very careful with opening the packaging

Once delivered to the purchaser, they must immediately check that the product is correct and conforms:

- 1) No part of the product must be damaged or cracked, or have any other visible defects due to transportation.
- 2) All the components must be in the package.
- 3) There must be no signs of chemical attack, damp, stains or anything else.
- 4) The CE Mark and pictograms must be included, especially:
 - The motor's identity label, which also indicates its characteristics.

Do not dispose of packaging in the environment. It must be deposited at specific collection points and stored in accordance with the specific environmental disciplines, by the user.

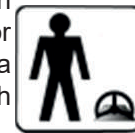

3.1 Handling

The Ceiling Fan is relatively heavy (see weights table) and bulky, and so it must be lifted and handled after having checked that the necessary, suitable equipment is available. They must have personal protection equipment required for the task and called for by applicable local norms. Also, given the weight of the machinery, if suitable lifting devices are not available, the machine and its components must always be handled by at least two people.

In particular:

For unpacking the product, use at least:

- GLOVES that are suitably resistant to cuts, perforation and crushing
- Overalls or approved clothing, type approved in terms of applicable norms
- Safety footwear

Operators engaged in unpacking the ceiling fan must be adequately trained and informed by the user of the elements and the dangers they pose.

3.2 Operative instructions

- a. Transport the pack that contains the product using adequate equipment, handled / operated by qualified personnel, to the vicinity of the assembly and/or installation site;
- b. Follow all the instructions given in detail. If a passage cannot be understood, or even if there is some doubt concerning it, immediately interrupt operations, make the machine and the parts in-volved completely safe, and ask for clarification. .
- c. Once all UNPACKING operations have been completed, proceed to install in the manner specifi-cally indicated.

The CEILING FAN can be lifted and suspended using the base of the machine as a support. Only lashing and securing methods may be used that ensure the machine's stability and prevent a risk of it falling during the op-eration. The area underneath must be cordoned off and kept free of people or objects, until after the fan has been started for the first time.

WARNING!

Before moving the equipment, you must:

- a. Stop the machine;
- b. Switch off the power supply;



To lift the machine, use adequate lifting gear (see weights table).

Lift it slowly, being careful that it does not fall, and move the belts according to the centre of gravity. Only lashing and securing methods may be used that ensure the machine's stability and prevent a risk of it falling during the operation.

3.3 Warranty

This equipment is guaranteed for 24 months from the date of production, for any faults due to proven factory or material defects. The guarantee does not cover parts damaged in transit, due to poor or incorrect maintenance, negligence, unskilled use, improper use, tampering by unauthorised personnel and/or, due to any cause for which VORTICE S.p.A. Company is not responsible. During the guarantee period, VORTICE S.p.A. undertakes to replace or repair parts of the product free of charge, that are found to have been defective from the outset, provided they are reported by the user immediately or at most within 15 days of discovering the fault in the product.

Malfunctioning of the ceiling fan due to faults in components and/or irregularities relating to parts of the product not reported immediately, in the specific manner indicated in this manual or the sales agreement, may not, under any circumstances, infer responsibility on VORTICE S.p.A.'s part, and must be seen to be the user's risk and danger due to unforeseeable use.

Work under guarantee must be done in VORTICE S.p.A.'s premises, with transport paid for by the user.

3.4 Storage and landing-up

The product must be kept in a cool, dry place, not subject to high humidity percentages, and correctly positioned on shelves or pallets. Especially the aluminium blades must be placed on adequate shelves, which does not allow them to bend. In any case, when drawn from the stores, check that they are not curved. The product may be stored for 6 months, after which we recommend checking that the electric motor is working properly, before installing it. Check that there are not cracks or breaks in metal parts of the ceiling fan, especially in the blade fixing hub or the blades themselves.

4 ASSEMBLY

Specific assembly and disassembly instructions – see the assembly instruction manual

5 INSTALLATION

5.1 Preliminary operations

For the CEILING FAN to work, the following are required:

- Electricity supply with suitable voltage and frequency characteristics for the machine, an earth connection and protective devices;



Installation must satisfy the safety re-quirements laid down by current local norms.



Then check that all the connections necessary for the equipment to work have been formed correctly by expert personnel, according to all the specific disciplines in this regard. VORTICE S.p.A. does not accept any responsibility for damage and/or malfunctioning due to connecting the product to the power supply in a manner that does not conform to the requirements laid down herein.

5.2 Positioning

Once the ceiling fan has been assembled, installation operations can begin.

Make sure you have understood the enclosed Assembly Instructions fully. To position the unit, the specialist, trained operator, in terms of the requirements above, must take the following precautions:

- The use of specific PPE is absolutely necessary, and in particular the operator must use at least working gloves, approved clothing that ensures high visibility, safety footwear, and a protective device for their head
- Before beginning installation, make sure the place available is suitable for the purpose. Especially check the connections, structure of the support / fixing point, distance from heat sources, high voltage lines, and/or other elements that may interfere with the machine's operation in some way, distance from the ground, and the operators involved.
- Before proceeding with installation, assess the possible interference risks between the operations to be carried out, fixed and moveable equipment to be used, and the working environment in which installation is to be done, according to the reference national norms.
- Proceed to install the product and its control panel in an accessible place that allows regular functioning to be checked visually at all times from the ground. It must also allow quick stoppage in case of emergency, as well as correct routine and extraordinary maintenance by authorised operators.
- Check that no operator is under or in the proximity of the installation site, until after the unit has been used for the first time.
- Make sure that the minimum lighting level in the installation area is at least 50 lux, to allow maintenance to be carried out and the equipment to be identified, as otherwise it may not be seen and perceived when it is running. We also advise against installing the ceiling fan below light sources that may generate a stroboscopic effect, which would be bothersome for the operators.

Once the checks indicated above have been completed, install as per the specific procedures listed below:

For installing and using the machine for the first time, see annex 1 to this Manual, "Assembly Instructions".

5.3 Optimum installation conditions

The ceiling fan must be installed at least one metre below the ceiling and at a height of 4 metres above the floor. The installer is also to assess any interference with machinery, balconies, balustrades, or anything else between the floor and the machine, that may interfere with it. Before beginning installation, the area must be specifically signposted and cleared of people or objects that may get in the way or be damaged by accidental falling of parts of the machine. The area over which the ceiling fan's action is effective is about 3 times the diameter of the fan. The manufacturer expressly forbids installations in which no space is left between one machine and another equal to the diameter of the machine itself. The installer is fully responsible for connecting the ceiling fan to the ceiling. They must therefore assess the most suitable fixing system in order to ensure that the unit is fixed in a workmanlike manner, according to the type of ceiling, beams or structure in general to which the fan is to be anchored.

5.4 Tightening torque

It is necessary use a torque wrench or a calibrated screwdriver in order to respect the following tightening torque:

- M8 Screw: 27 Nm
- M10 Screw: 53 Nm
- M12 Screw: 92 Nm

5.5 Tie bars

The Manufacturer markets and provides a specific metal tie bar kit for the ceiling fan, supplied if requested by the purchaser.

This tie bar kit ensures additional axial stability for the ceiling fan, and keeps it at its height if, due to outside causes, the machine is stressed anomalously, or the ceiling assembly with just one central pole, does not ensure adequate solidity over time

The installation **MUST** be completed using the tie bar kit for safety reasons, if the purchaser or installer finds any of the following, in the actual production situation and installation position of the ceiling fan inside the industrial building involved:

- The possibility that the ceiling fan may be struck by gusts of wind (e.g. opening of doors or windows), or that the ceiling fan is installed in buildings that can be opened on the sides
- The possibility that the ceiling fan may inadvertently be struck by machines or equipment used by the purchaser or others, working inside the building in which the fan is installed
- The possibility that the ceiling fan may be struck by flying creatures, flying around inside the building in which it is installed.
- The industrial building is located in an area defined to be seismic or, in any case, subject to appreciable sources of vibrations that affect the building.

WARNING: Since the assessment of the need to do the installation with an additional tie bar kit depends completely on objective conditions related to the property, the type of production activity and mode of the same, and these conditions cannot be ascribed to the Manufacturer, the Manufacturer does not accept any responsibility for not using the tie bar kit for installation, while stating that its use is preferable and safer.

Installing the ceiling fan in the presence of winds or draughts that strike the machine on the side, with wind speeds greater than or equal to 14 m/sec, is expressly forbidden. For wind speeds of between 10 and 14 m/sec, use of the tie bar kit for installation is obligatory, and the machine is already set up for the same.

In the case of strong side winds that strike the ceiling fan, in addition to wind bracing in the form of the tie bar kit, it is important that the machine is never stopped, but continues to rotate at minimum revs, in order to balance the side forces that strike it.

We do not advise using the ceiling fan in dusty settings, such as places in which flour or light, easily volatile elements are present.

5.6 Noise emissions

The acoustic pressure level of pondered emission A in workplaces does not exceed 70 dB(A).

5.7 Cleaning

The machine can be cleaned using products suitable for cleaning aluminium and steel. Each cleaning operation deemed necessary, must be done with the power supply to the machine disconnected. Suitable precautions must be taken to avoid subsequent untimely switch-ons during the operations, and operators must wait until the fan has stopped rotating. Aiming pressurised water towards the ceiling fan for cleaning operations is expressly forbidden, even though the machine is in class IP65.

5.8 Electrical connection

The installation involves the use of a control unit with an output of 1 - 10 V. However, as an alternative a manual potentiometer can be used, the only difference being that starting and stopping the machine must be done manually. Each control unit chosen by the client must be CE certified, or must at least conform to the low voltage and electromagnetic compatibility directives. Failure to ensure this will render the warranty null and void, due to damage caused to the machine due to the use of unsuitable material. However, this choice does not affect the installation procedure described below.



- The electrical connection is to be formed by recognised, specialist technicians, authorised in terms of the current norm
- Make sure that the characteristics of the electricity supply conform to the indications.
- It is mandatory to connect the equipment to an effective earth line.

The installation must include a device for disconnecting the equipment from the mains

power supply. A protective fuse must also be installed, adequately sized and of a delayed type for starting motors. Attaching or hanging any object from the ceiling fan's blades for any reason, is forbidden. This is because such actions could result in the machine being out of balance, with a resulting anomalous distribution of loads and consequences such as the machine falling.

WARNING: SPECIFICALLY INSERT A SINGLE POWER SUPPLY LINE, FITTING A CLASS A TRIP SWITCH IN THE LINE, IN ADDITION TO A PROTECTIVE CIRCUIT BREAKER IS OBLIGATORY. INSTALLING THE CEILING FAN NEAR HIGH VOLTAGE LINES (GREATER THAN 1000 V ALTERNATING CURRENT OR 1500 V DIRECT CURRENT) IS EXPRESSLY FORBIDDEN.

6 OPERATION

6.1 Preliminary operations

Before starting the ceiling fan, check that:

- 1) All electrical connections have been formed according to the instructions given in this manual;
- 2) The ceiling fan is free and clean;



6.2 Starting for the first time

Once assembly, installation and the electrical connection for the machine have been completed, power the machine and wait for about 30 seconds to allow it to complete a self-diagnosis of its default parameters, and then start rotating. Subsequently, check that:



- a. There is no imbalance in the installation due to incorrect assembly of components, or latent defects in the same.
- b. There are no metal noises or sounds coming from the machine itself
- c. The motor's diagnosis LED flashes every 2 seconds.
- d. Rotation is clockwise, when looked at from below the ceiling fan.

6.3 Emergency stoppage

In an emergency, switch off the power supply to the machine via the circuit breaker or the main power supply set up. **Warning!** Do not touch the machine for a period of 5 minutes after switching off the power, because the outside temperature of the machine may exceed 70°C. .

6.4 Starting

The machine starts automatically as soon as electricity is supplied to it, after a delay of about 30 seconds to allow automatic setting of the operating parameters. To start the ceiling fan correctly, see the installation manual enclosed with this manual. The fan speed is adjustable by a potentiometer standard supplied. The maximum fan speed is indicated in the 8.1 Technical Data Table.

7 MAINTENANCE



Before doing any maintenance work, isolate the equipment from the power supply!

7.1 Routine maintenance

The product must be kept clean and protected against agents that may harm its integrity or use. The machine does not require routine maintenance.

7.2 Periodic checking

Frequency	Activity	Activity	Activity	Activity	Activity	Activity	Activity
Monthly	1						
Yearly		2	3	4			
2 Years					5	6	
5 Years							7

Activity legend

1	Visual check Check direction of rotation Check abnormal vibrations Check LED operation
2	Check structural integrity Check star shaped blade fixing General cleaning
3	Check screws tightening and resistance Check blade integrity Check connector power and signal
4	Full cleaning by dust and other
5	Check bracket and screw tightening Check anti-fall plate tightening (where required)
6	Check state of corrosion or oxidation
7	Verify state and eventually change the star shaped blade fixing and star reinforcement

7.3 Extraordinary maintenance

Extraordinary maintenance refers to work on the electronic board, and replacing blades or other mechanical parts. The methods are described in the assembly manual enclosed.

ALL maintenance operations, including extraordinary maintenance tasks, must be strictly done with the machine stopped and disconnected from the electricity supply, by a specialist operator trained as indicated in this manual. All precautions must be taken to avoid anyone inadvertently powering the plant while extraordinary maintenance work is in progress. We therefore recommend adequately indicating the fact that the power must not be switched on during the operations, using suitable means (e.g. locking the electrical panel with a key). The specialist personnel involved must wear specific personal protection equipment, especially working gloves, protective hard hat, and safety footwear. For work done at a height, adequate means must be used such as a scaffold or mobile platform that can be raised. All of these must have strong hand railings in good condition. Personnel working at a height must be equipped with the necessary devices to prevent them falling. At the time of the work, the personnel must ensure that they are not exposed to a risk of being struck by another ceiling fan, adjacent to the one they are working on. If this is the case, the other machine must also be disconnected. On completion of the operations, before powering the machine again, all the people and equipment involved in the works must be removed and take a safe distance to the side of the blades of about 1 m, while below the machine there must be no impediment within about 2,7 m of the fan.

Maintenance records

We believe that for safe use of the product it is important that the user sets up a suitable register for routine checks and maintenance done, in the form called for by applicable local norms. This may be based on the "Periodic Check" table above, which may be developed graphically to form a checklist with tick boxes for the individual tasks carried out.

We recommend that accurate records be kept of each activity and/or maintenance task and/or replacement, indicating the operator, with adequate space for recording any anomaly or problem encountered.

We recommend that the safety instruction warning be clearly visible on the register as well: "If in doubt as to any operation being carried out on the machine, interrupt the work, make the machine completely safe, and contact the manufacturer to obtain the necessary technical clarifications".

8 TECHNICAL CHARACTERISTICS

8.1 Technical data

Data	NORDIK HVLS 300/120" T	NORDIK HVLS 400/160" T	NORDIK HVLS 300/120" TL	NORDIK HVLS 400/160" TL	NORDIK HVLS 500/200" T	NORDIK HVLS 600/240" T	NORDIK HVLS 700/280" T	NORDIK HVLS 500/200" TL	NORDIK HVLS 600/240" TL	NORDIK HVLS 700/280" TL	NORDIK HVLS 700/280" ST	NORDIK HVLS 700/280" STL
Motor weight [kg]	35	35	35	35	45,5	45,5	45,5	45,5	45,5	45,5	56,5	56,5
Fan Blade weight [kg]	21	29,5	21	29,5	38	46	54	38	46	54	54	54
Total weight [kg]	86	94	86	94	113	121	129	113	121	129	140	140
Max consumption [W]	600	650	600	650	850	1100	525	850	1100	525	665	665
Power supply	200-480V ~ 50-60 Hz											
Absorbed current [A]	1,43	1,67	1,43	1,67	1,97	2,69	1,35	1,97	2,69	1,35	1,65	1,65
Maximum speed [RPM]	160	100	160	100	80	65	38	80	65	38	50	50
Minimum speed [RPM]	6	6	6	6	6	10	10	6	10	10	10	10

8.2 Spare parts list



Only original spare parts are to be used for all units made by VORTICE S.p.A (see spare parts table on the Vortice website / alternatively contact the Vortice assistance centre). The manufacturer does not accept any responsibility resulting from the use, assembly, removal, insertion, connection or any other operation in the machine, done using pirate parts or parts not expressly approved by VORTICE S.p.A., as well as any works done by operators not authorised for the purpose by the Manufacturer, or trained by them

Orders are to be made, indicating the following information:

- Equipment model
- Item reference as shown in the drawing.
- Quantities of parts ordered
- Client's address

9 TROUBLESHOOTING



Before doing any maintenance work, isolate the equipment from the power supply and shut off the water supply!

PROBLEM	CAUSE	SOLUTION
The machine does not start	The power is not on.	Check the electrical connection or the mains power supply.
The fan does not start.	The power supply to the motor is not on.	Check the electricity supply to the motor.
	The motor is faulty.	Contact specialist, authorised personnel to replace the motor. .
The machine vibrates	The fan is dirty or broken.	Contact specialist, authorised personnel to replace the fan.

VORTICE S.p.A.
 Strada Cerca, 2
 Frazione di Zoate
 20067 Tribiano (Milano)
 ITALY

Ph: (+39) 02 906991

www.vortice.com

Attachment 1

Assembly Instructions

Assembly blade support to motor

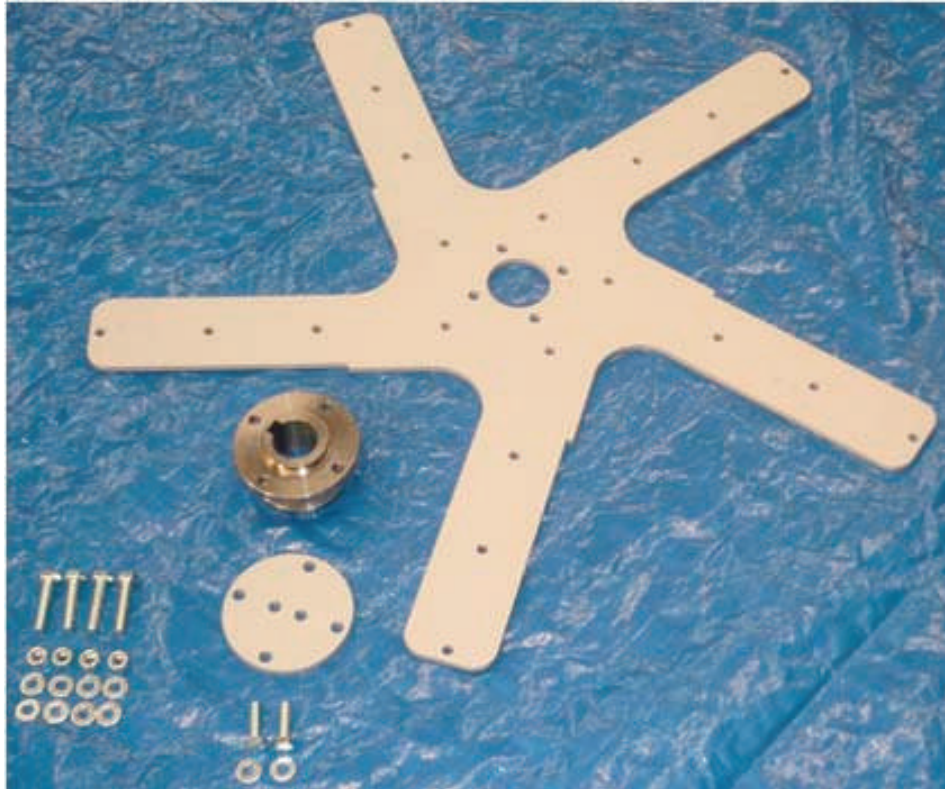

STAR BLADE SUPPORT



FIXING PLATE DISK



HUB



*SCREW M10x45 TE
SELFBLOCK BOLT M10
NUTS 10,5x20 h2*



*SCREW M10x35 TE
NUTS GROWER D.10*

Assembly blade support to motor

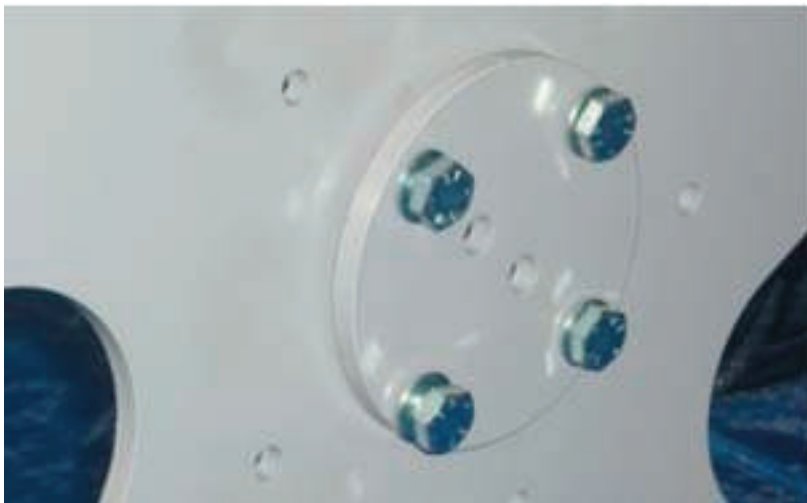

*INSERT PLATE INTO BLADE SUPPORT USING
SCREWS M10x45 TE
NUT. 10,5x20 h2*

*ATTENTION:
Check right side of the star Blade Support*

Assembly blade support to motor

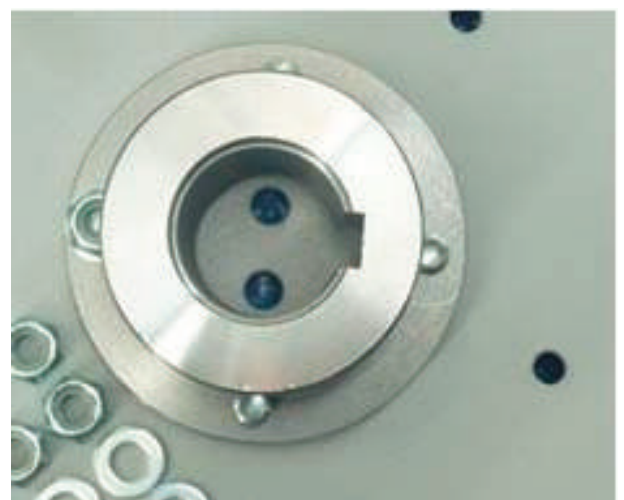

ATTENTION:
Place hub with tab seats oriented as per picture at side

*POSITION HUB AND CLOSE NUTS 10,5x20 h2
TO SELFBLOCKING BOLT M10*

Assembly Blade Support on Motor

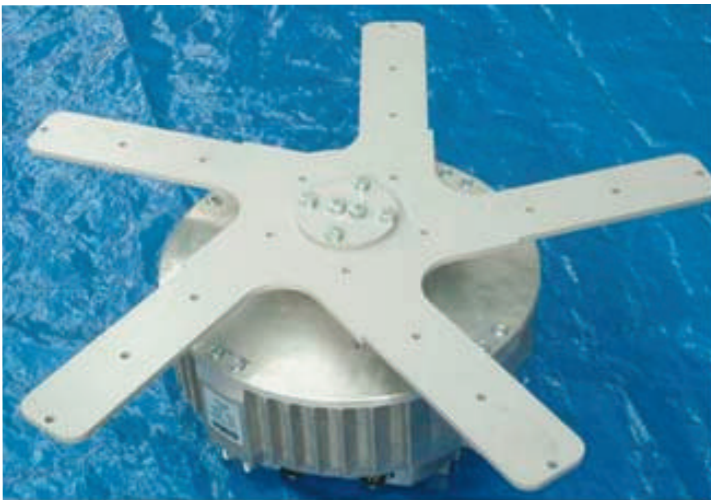

*PLACE BLADE SUPPORT WITH DISC OVER THE SHAFT AND CLAMP SCREWS
M10x35 TE
WITH NUTS GROWER D.10*

Safety holder assembly



SAFETY HOLDER



*SCREW M8x25 TCEI INOX
(already available into motor)
NUT. GROWER D.8
(already available into motor)*

Safety holder assembly



*PLACE SAFETY HOLDER AND FIX THEM WITH SCREWS
(Already available into motor)*

Assembly motor holder



MOTOR HOLDER

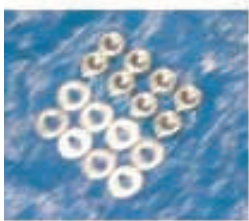

*SELFBLOCKING BOLT M10
NUT 10,5x20 h2*

*POSITION MOTOR HOLDER OVER MOTOR
CLAMP NUTS AND BOLTS*

Assembly Winglet on blade



*POSITION THE WINGLET AT BLADE TIP
FIX WITH PROVIDED SCREWS and NUTS*



WINGLET

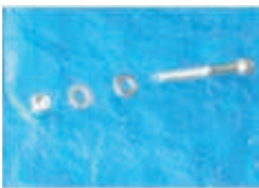

*SCREW M8x60 TCEI
WASHER 8,4x16 h1,6
SELFBLOCKING BOLT. M8*



*BLADE
Code indicated in the Component table*

Assembly blades on support– Assembly to be made after fan positioned at final destination



*SCREW M8x60 TCEI
NUT 8,4x24 h2
SELFBLOCKING BOLT M8*

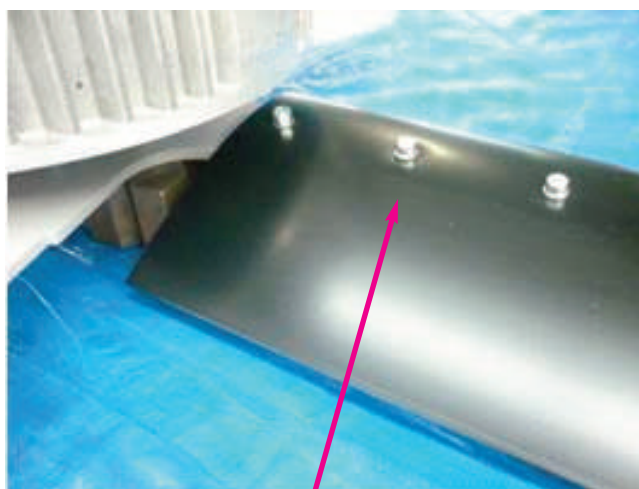
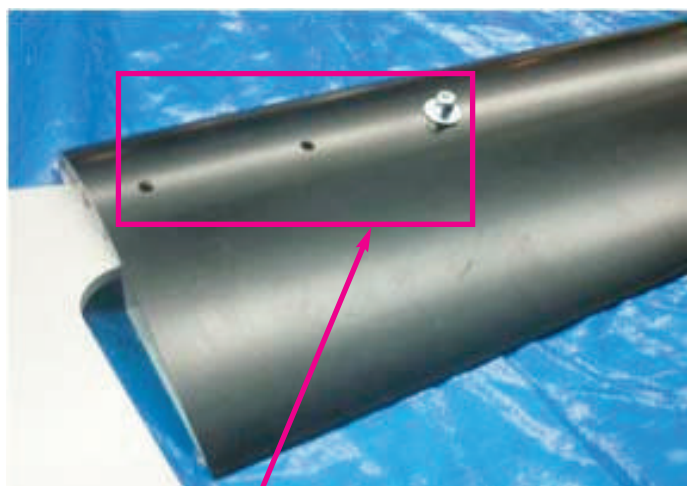

Blade's top face fixed with selfblocking Bolts

ATTENTION:

Screws must be assembled with the head of the screw on the bottom face of each blade

*PLACE BLADE INTO FIXING BLADE.
FIX THEM WITH SCREWS, NUTS AND BOLTS.*

Assembly rod holder and rod



ATTENTION:

Rod holder position is in rod side with 2 holes



ROD HOLDER



*SCREW M12x90 TE
NUT D,14x36 h2,5
SELFBLOCKING BOLT M12*



ROD



*SCREW M12x90 TE
NUT. D,14x36 h2,5
SELFBLOCKING BOLT M12*



Assembly rod holder and rod



PLACE ROD INTO MOTOR HOLDER AND FIX WITH SCREWS, NUTS AND BOLTS

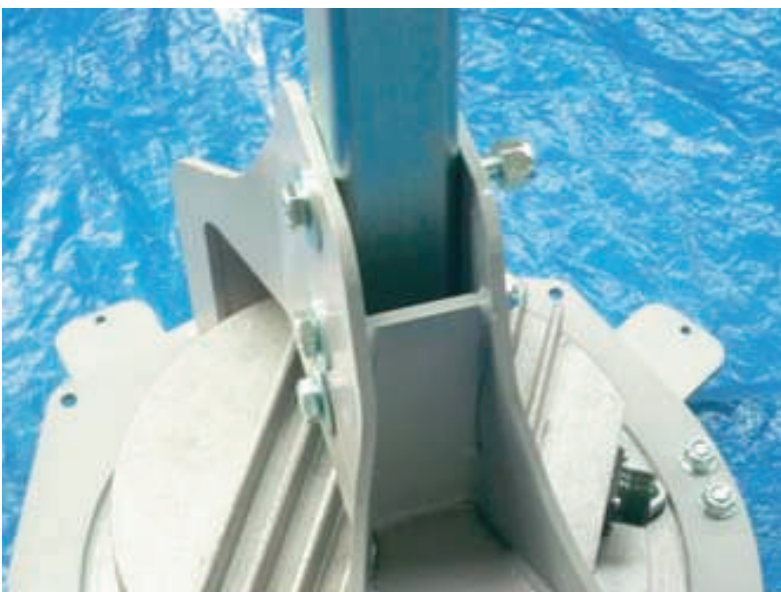

Assembly rod holder and rod

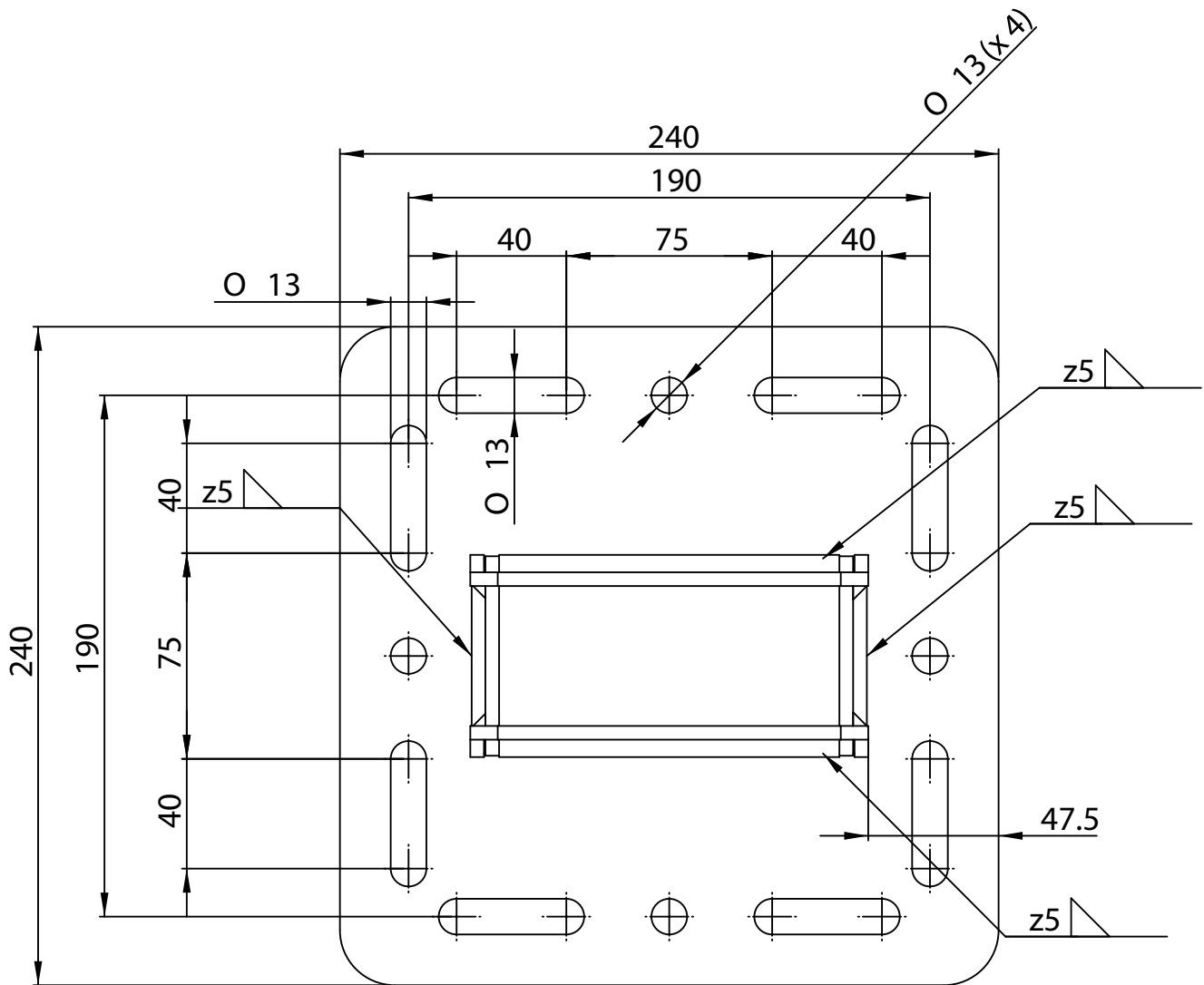
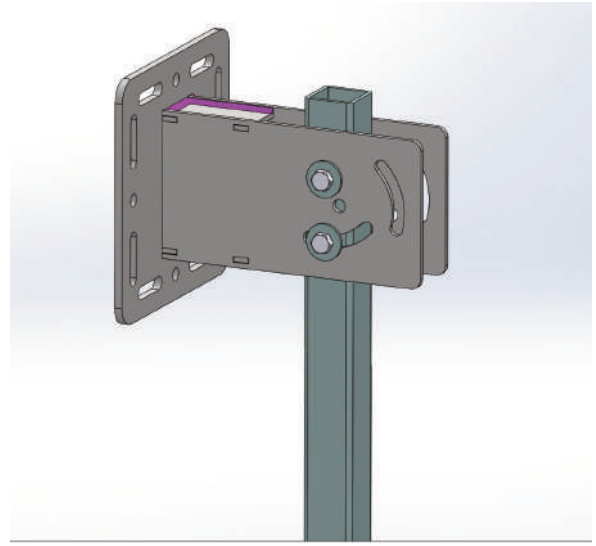
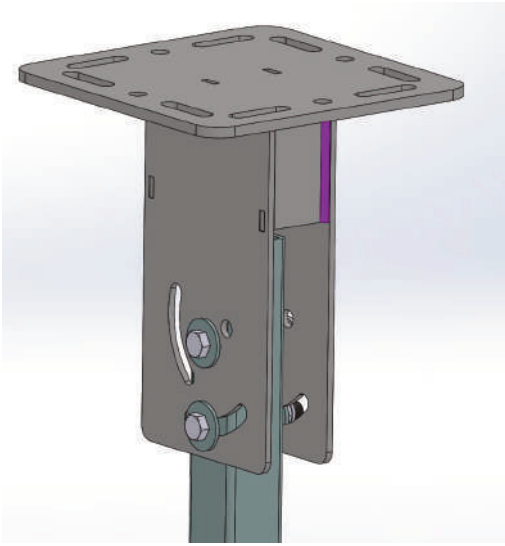

PLACE ROD INTO ROD HOLDER AND FIX WITH SCREW, NUTS AND BOLTS
ASSEMBLY POSITION FOR ROD HOLDER DEPENDS ON INSTALLATION STUDY AND DESIGN

Assembly Star blade holder - Material



Main star blade holder



Reinforced star blade holder folded + spacer



*SCREW M8x45 TCEI
NUT 8,4x24 h2
SELFBL. BOLT M8*

*To assemble 5 central screws Rein-for-
ced Spider to Main Spider*



Bottom cap

Assembly Star blade holder - Instructions

For a correct assembly it is necessary follow the correct sequence, as indicated:

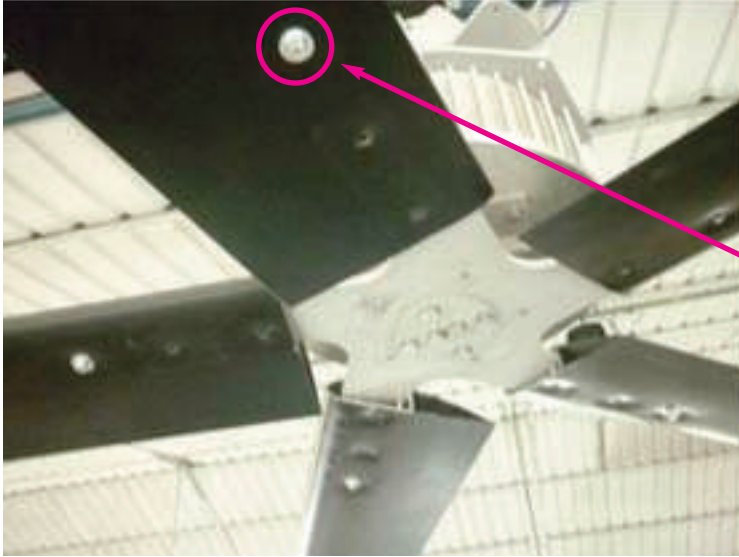

- *Fix the Main Star blade holder to the Hub*
- *Put the blades in the Main Star blade holer's spokes centering the blade mounting holes (by using a screwdriver)*
- *Fix without tightening the external screw for each blade with bolts and nuts*
-

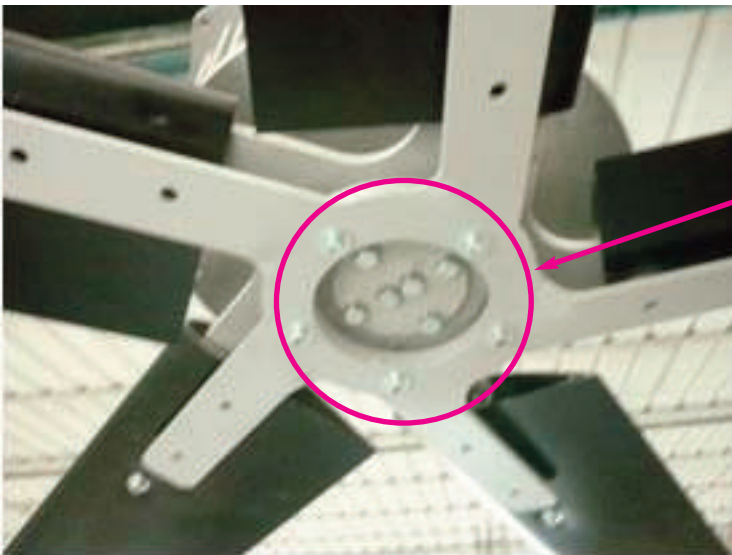

- *Fix without tightening the 5 central screws of the reinforced star to the main one, with bolts and nuts*

Assembly star blade holder - Instructions

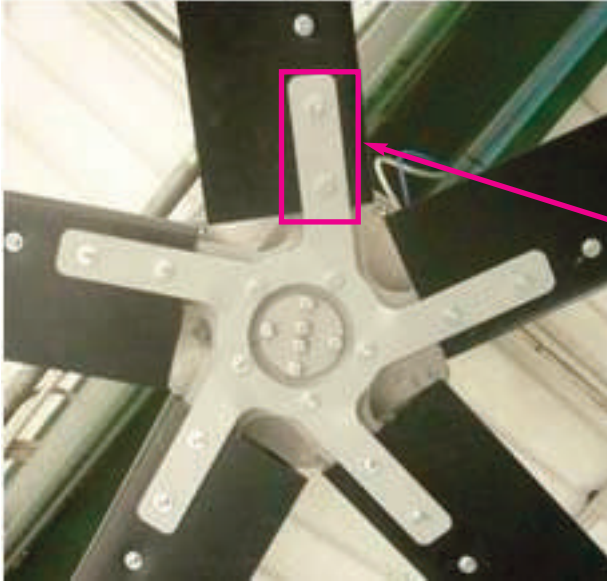

- *Put the other 2 screws in each blade without tightening with bolts and nuts*
- *Tight the 5 central screws already fixed.*
- *Tight the screws to fix the blades*
- *Put the hooks of the bottom cap into the holes of the space.*

N.B: The M8 screws tightening torque is 27 Nm

Assembly Fan completed

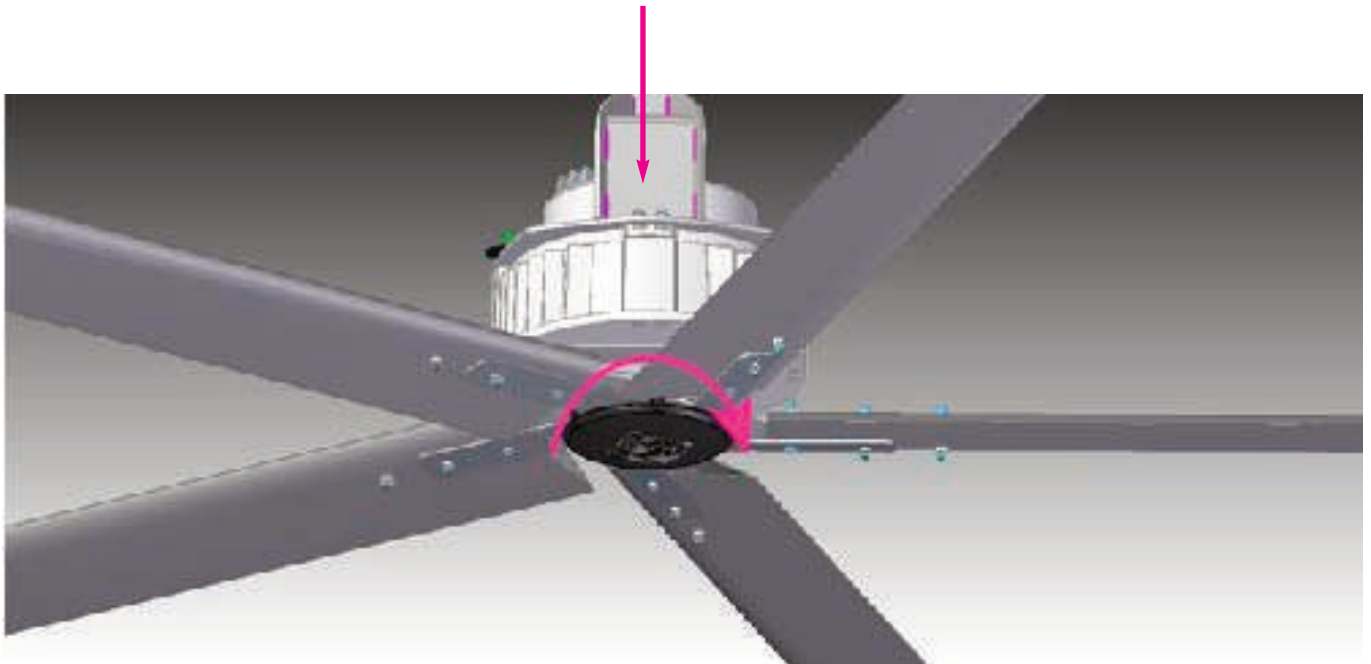

Clockwise rotation (bottom view)

Connector assembly - Instructions

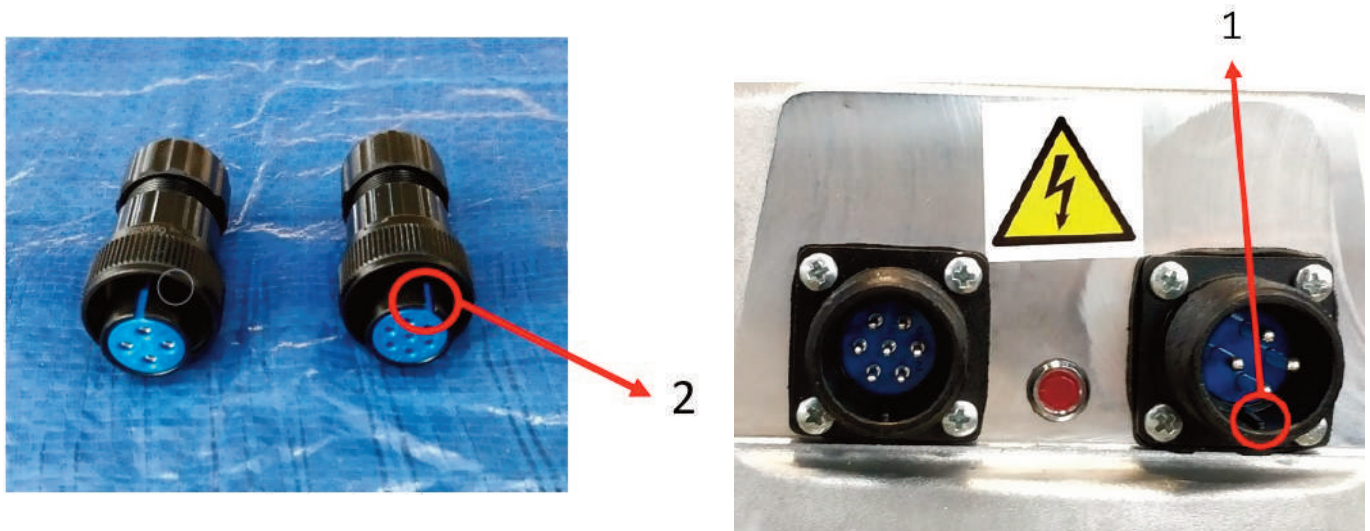

INSERT THE POWER AND SIGNAL CONNECTORS INTO THE MANAGEMENT CARD, TAKING CARE TO MATCH THE PIN (1), WITH THE SLOT (2).

First Start

After having assembled complete fan, connected power and controller lines, give power to machine and wait about 30 seconds until it start to run, be-cause machine need 30 seconds to autosest all parmeters.

After that check following:

- *No rotation unbalancing due to wrong components assembly*
- *No noise coming out from machine*
- *Motor led light every 2 seconds to test everything is fine*
- *Fan Rotation must be clockwise, if seen from below the fan*

Tie Bar Kit

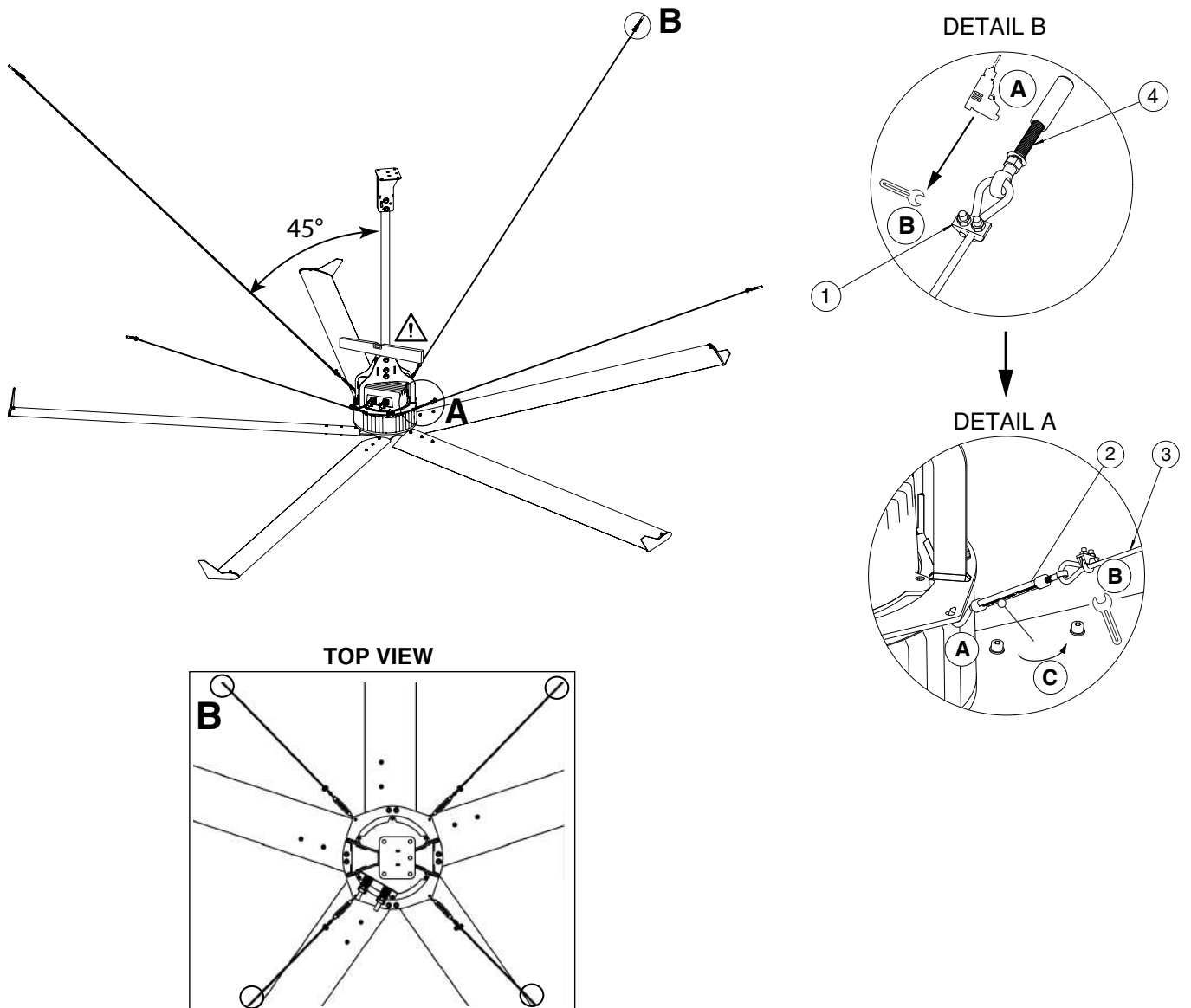

Cod. 20193 HVLS SUPER BLADE-RD		
No.	DESCRIPTION	Q.TA'
1	CAST IRON CLAMP	8
2	M8 VERZINKT SPANNER	4
3	GALVANIZED CABLE 49THREADS DIAM. 5	20 m
4	M8 ANCHOR BOLT	4

Disassembly Fan – POWER



TURN OFF POWER
REMOVE POWER AND SIGNAL CONNECTORS

Disassembly Fan – POWER – Operation with motoinverter connectet to the roof

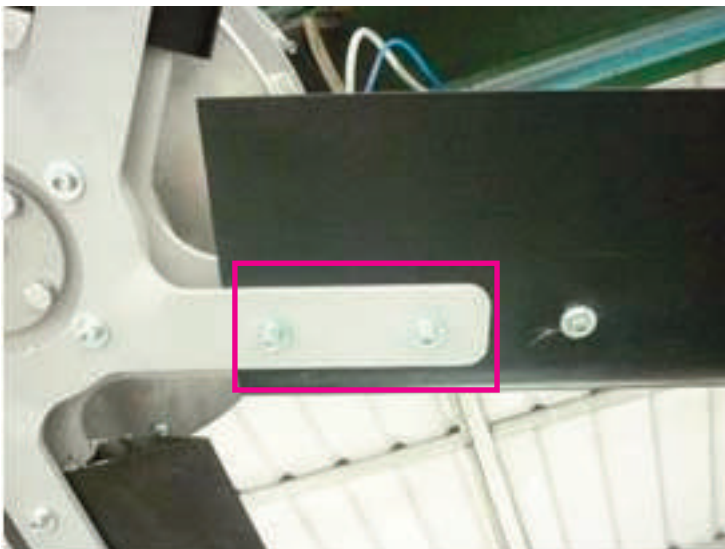

*SCREW M8x60 TCEI
NUT 8,4x24 h2
SELFBLOCKING BOLT M8*

UNSCREW AND DISASSEMBLY BLADES

ATTENTION:

Operation require you use adequate support to substain blades and their weight, so please prepare everything before start operation

Disassembly fan– WINGLET – Operation to be made with blade to the ground

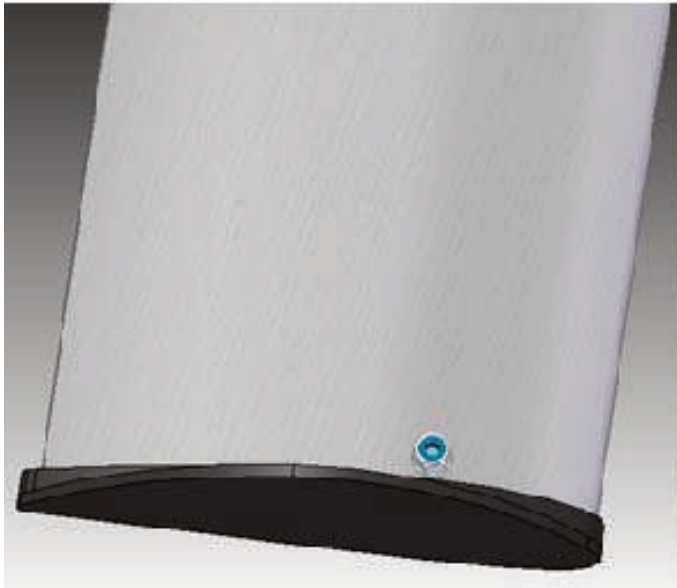

Loosen the screw fissing the plastic Winglet to the blade



WINGLET

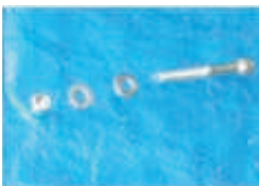

*SCREW M8x60 TCEI
WASHER 8,4x16 h6
SELFBLOCKING BOLT M8*



BLADE

Disassembly fan– MOTOINVERTER – Operation to be made with motoin-ver-ter fixed to the roof



*SCREW M12x90 TE
NUT D,14x36 h2,5
SELFBLOC. BOLT M12*

UNSCREW MOTOR HOLDER FROM ROD

ATTENTION:

Operation require you use adequate support to substain blades and their weight, so please prepare eve-rything before start operation

Disassembly fan– Blades support - Operation with Motoinverter on floor



UNSCREW MOTOR HOLDER FROM MOTOINVERTER



MOTOR HOLDER



***SELFBLOCKING BOLT M10
NUT 10,5x20 h2***

ATTENTION:

Use adequate support to avoid support blade to be direct in contact with floor

Disassembly fan– Blades support - Operation with Motoinverter on floor

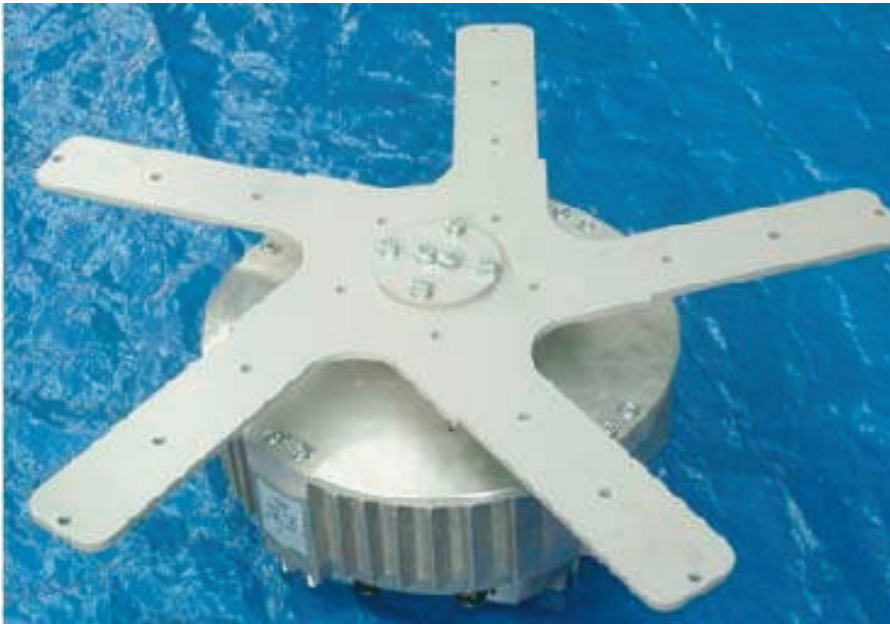

*SCREW M10x45 TE
SELFBLOCKING BOLT M10
NUT 10,5x20 h2*



*SCREW M10x35 TE
NUT GROWER D.10*



MAIN SPIDER



FIXING BLADE

UNSCREW BLADE SUPPORT FROM SHAFT AND HUB AND TAKE OUT PARTS

ATTENTION:

Rotate motor 180° to execute operation

Disassembly fan– HUB- Operation with Motoinverter to the floor



AFTER DISASSEMBLED BLADE SUPPORT, DISASSEMBLY HUB



HUB



SAFETY HOLDER



*SCREW M8x25 TCEI SS (already on the motor)
NUT GROWER D.8 (already on the motor)*

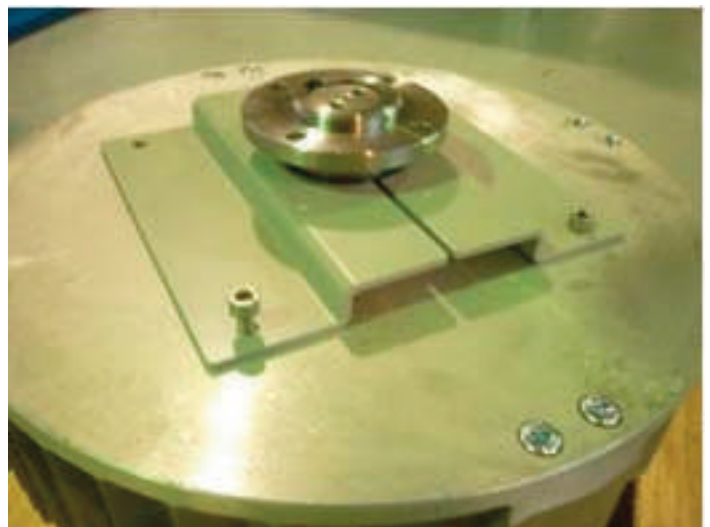

ATTENTION:

- A. The Hub is strongly connected to the shaft – You will need adequate extractor.*
- B. If present safety holder, before unscrew hubs disassembly safety holder*

Electronic board disassembly

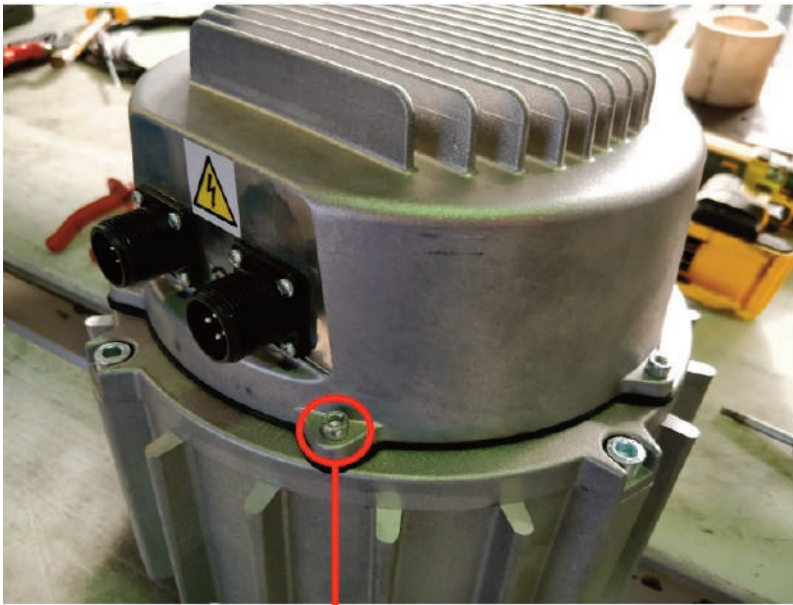

UNSCREW THE 6 M5 SCREWS

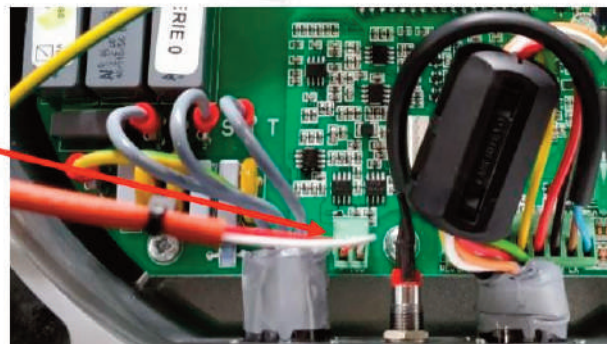
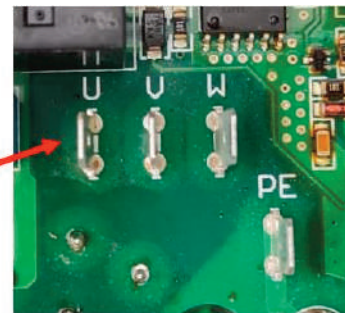
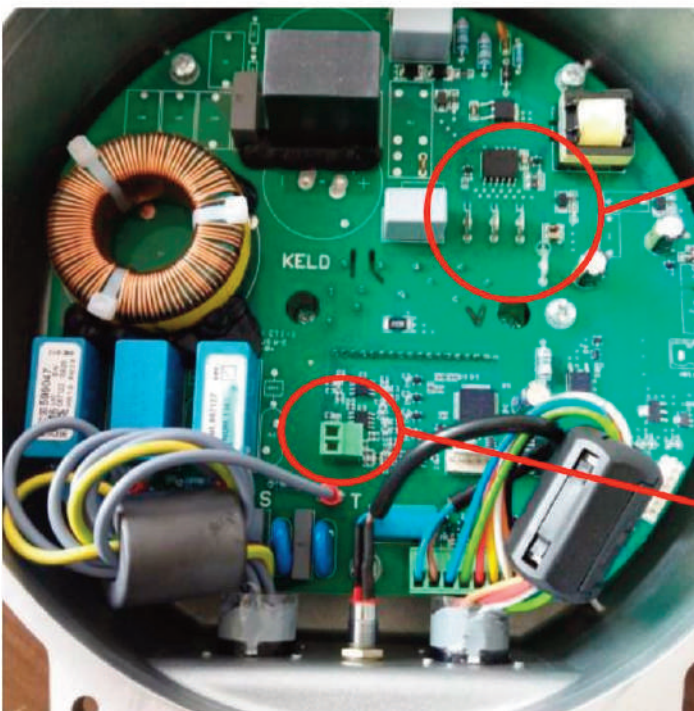

DISCONNECT THE FASTONS ON THE ELECTRONICS OF THE MOTOR PHASES AND PT100

Electronic board assembly

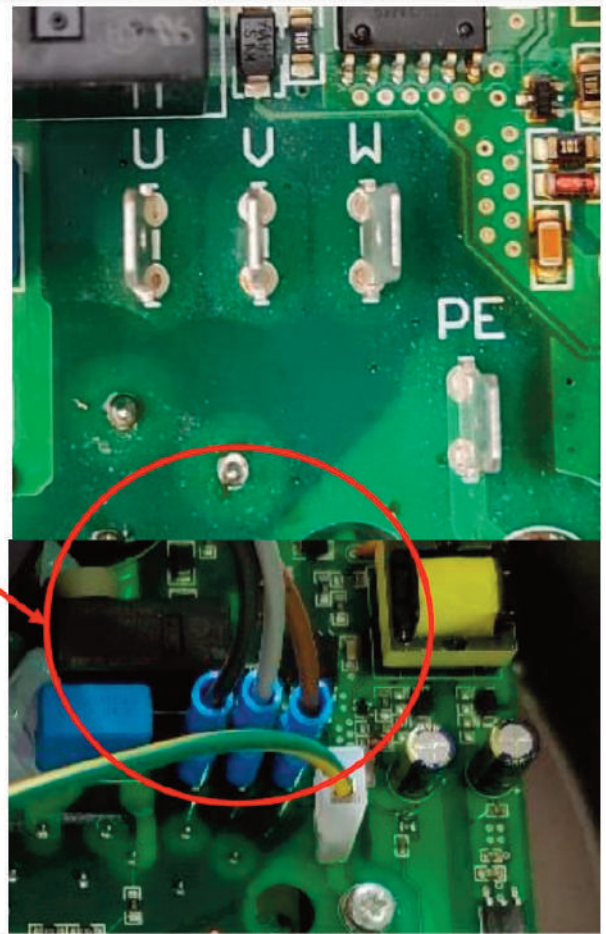

ENGAGE THE FASTONS ON THE ELECTRONICS OF THE ENGINE PHASE FOLLOWING THE FOLLOWING DIAGRAM:

U-BLACK

V-GREY

W-BROWN

PE-YELLOW/GREEN(EARTH)

Electronic board assembly

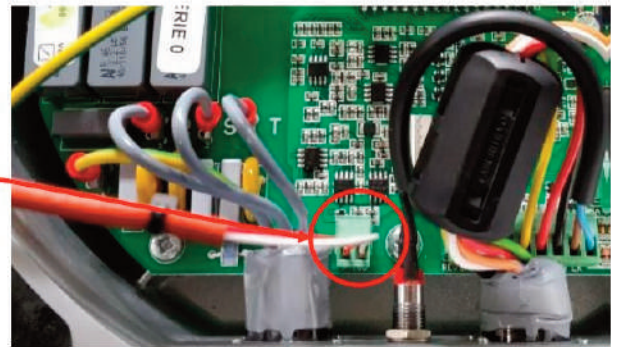
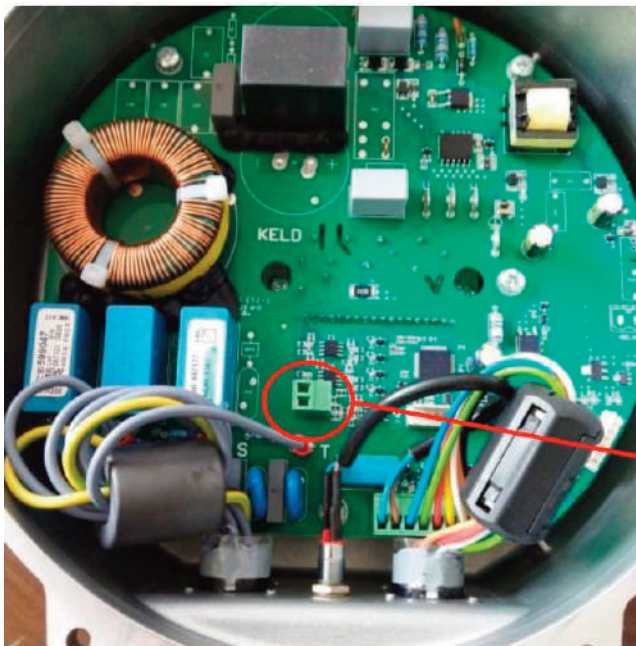

INSERT THE GREEN CONNECTOR, WITH THE WHITE/RED WIRES, OF THE ENGINE TEMPERATURE SENSOR INTO THE SPECIAL CONNECTOR ON THE ELECTRONICS (AS POSITIONED IN THE FIGURE).

Electronic board assembly

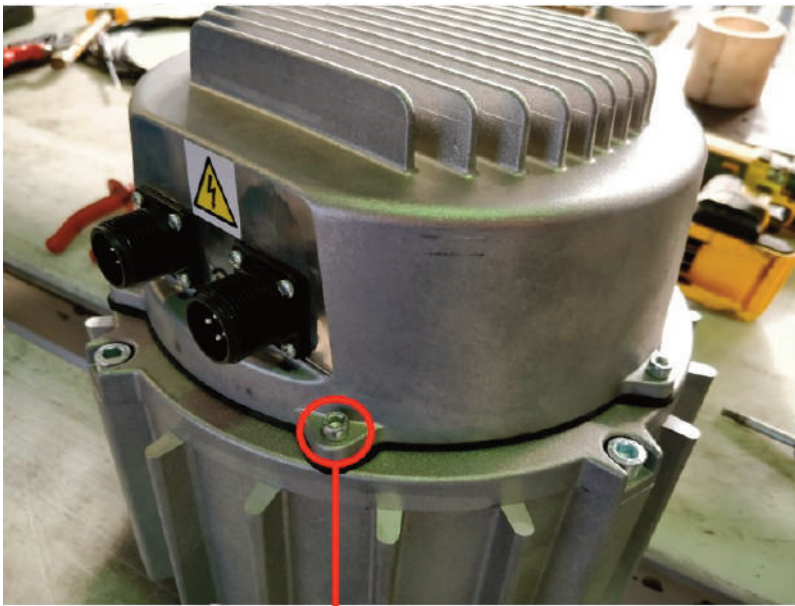

CLOSE WITH THE 6 M5 SCREWS



ATTENTION: MAKE SURE THAT NO CABLES ARE PINCHED WHEN TIGHTENING THE LOCKING SCREWS

Attachment 2

Electric connection

1. Power connection

The power supply must be provided by means of a line made with cable according to present load;

Energy power distribution is composed according to wire diagram supplied.

Power panel protect in MT (magnetotermic protection) line powering HVLS fan in one single area.

Every single HVLS fans line must be protected.

Power panel must be supplied by a dedicated line protected by adequate MT protection (minimum 20 A) and from a protection Dif-ferential A type.

The PE cable must be connected to a grounding system with impedance and characteristics such as to ensure the proper operating of the differential protections installed in accordance with regulations about indirect contact and no dissipation of stray currents.

Attention: line with MT+D (magnetotermic protection + HVLS fan) must be dedicated and not powered together with other devices. Cannot be derivated from other differential A type.

HVLS fan must be connected with its own connector to signal wire.

Togheter with power wire will be installed analogic signal wire (0-10 v ten-sion for fan speed control) and modbus signal able to control fan and modify parameter through a remote PC

The management takes place via:

10 Kohm Potentiometer

Modbus signal through a remote PC

Temperature probe control unit

*For analogic signal will be used a RS485 wire (2*2*AWG24 twisted and shielded).*

Shielded wire must be provided only from power panel side and not from fan side.

In case on signal line you are going to install junction boxes to connect single fan signal line to main line, between junction boxes and signal connector from inverter you must use same wire RS485 used for signal line.

For connection and wire colour, you have to follow electric diagram.

Warnings for maintenance and diagnostic actions

Many maintenance interventions and diagnostic actions of the fan can be done by remote connection.

In order to do this, it is, however, necessary to identify exactly the fan and connect to it.

Therefore, DURING THE INSTALLATION IT IS MANDATORY:

- 1) Pull always the 1 and 2 wires down to the switchboard (to connect with the fan)***
- 2) Set down in a scheme the Serial Number and the Modbus Address of each motor, as well as their placement (to univocally identify each single machine) in case of maintenance***
- 3) Verify that in the same line there are not installed two motors with identical Modbus Addresses.***

2. Table Model - Code - Power supply

Model	Code	200-480V THREE-PHASE 50-60 Hz	85-264V SINGLE-PHASE 50-60 Hz
NORDIK HVLS SUPER BLADE 300/120" T	61080	●	/
NORDIK HVLS SUPER BLADE 300/120" T L	61090	●	/
NORDIK HVLS SUPER BLADE 400/160" T	61081	●	/
NORDIK HVLS SUPER BLADE 400/160" T L	61091	●	/
NORDIK HVLS SUPER BLADE 500/200" T	61082	●	/
NORDIK HVLS SUPER BLADE 500/200" T L	61092	●	/
NORDIK HVLS SUPER BLADE 600/240" T	61083	●	/
NORDIK HVLS SUPER BLADE 600/240" T L	61094	●	/
NORDIK HVLS SUPER BLADE 700/280" T	61084	●	/
NORDIK HVLS SUPER BLADE 700/280" T L	61094	●	/
NORDIK HVLS SUPER BLADE 700/280" T S	61076	●	/
NORDIK HVLS SUPER BLADE 700/280" S T L	61077	●	/

Legend: ● Allowed connection
/ Connection not allowed

3. Wiring diagrams

- Destratifier line connection diagram

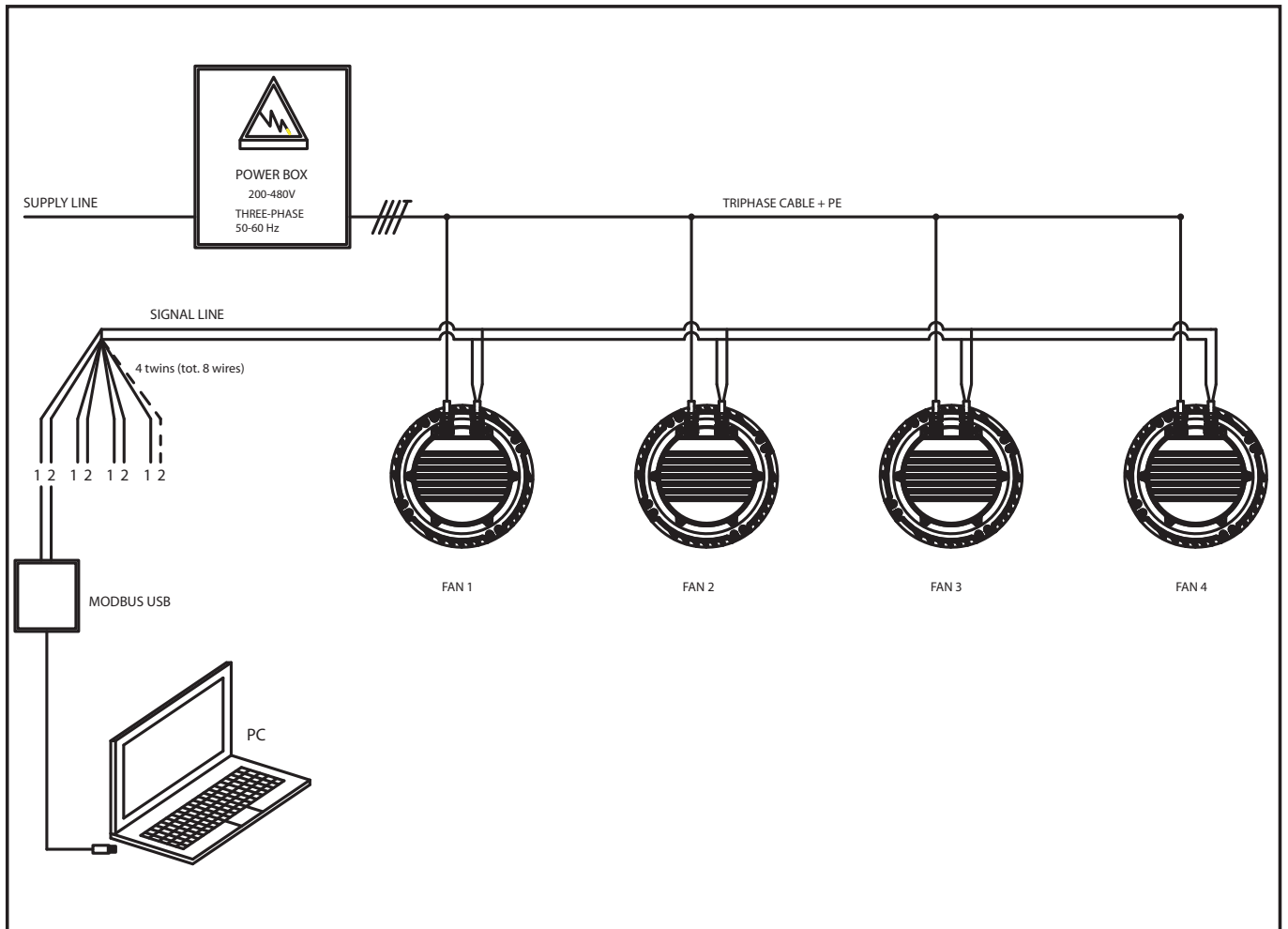

- Existing system wiring diagram

SUPPLY LINE 200 - 480V THREE-PHASE 50/60 Hz

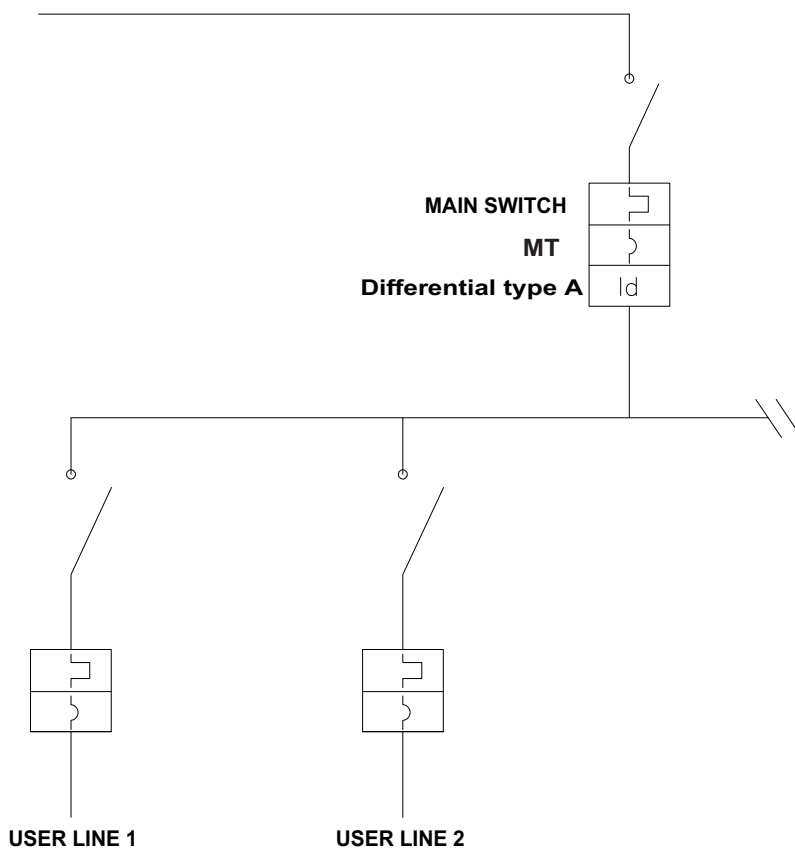

Dedicated line suitably protected with Magnetic-Thermal Switch and Differential Class A with a sensitivity of 300 mA.
The line must be taken downstream of the main switch of the system and be independent of other lines that feed the existing loads.
The operator will consider whether to keep or eliminate the Differential upstream of the load distribution.
It could create problems in the case where the leakage current to ground is substantial value.
Each ventilator has a leakage current of 2 mA.

- Multi-wire diagram for system wiring (three-phase)

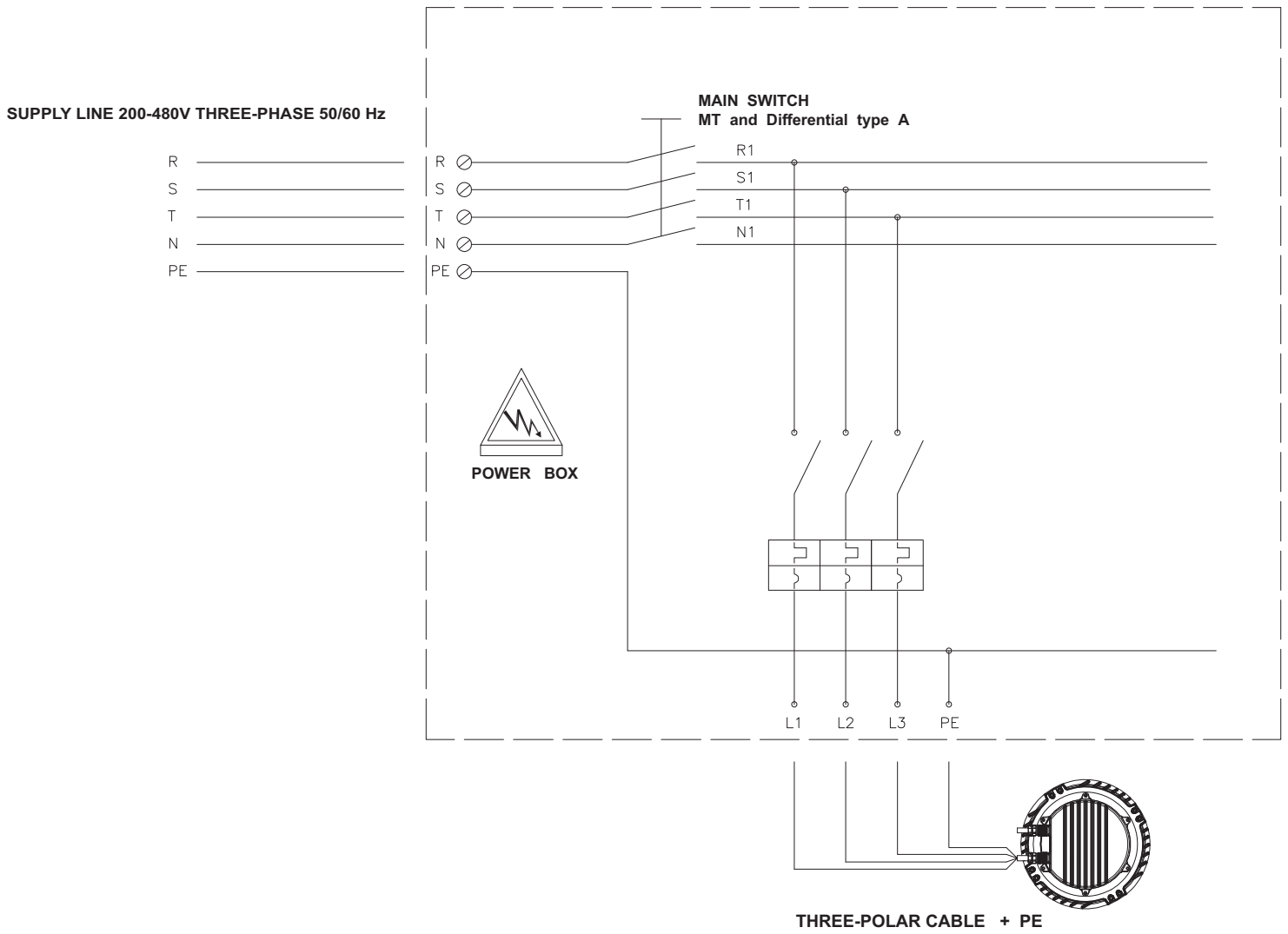

3. Connector Diagram and Pin Color

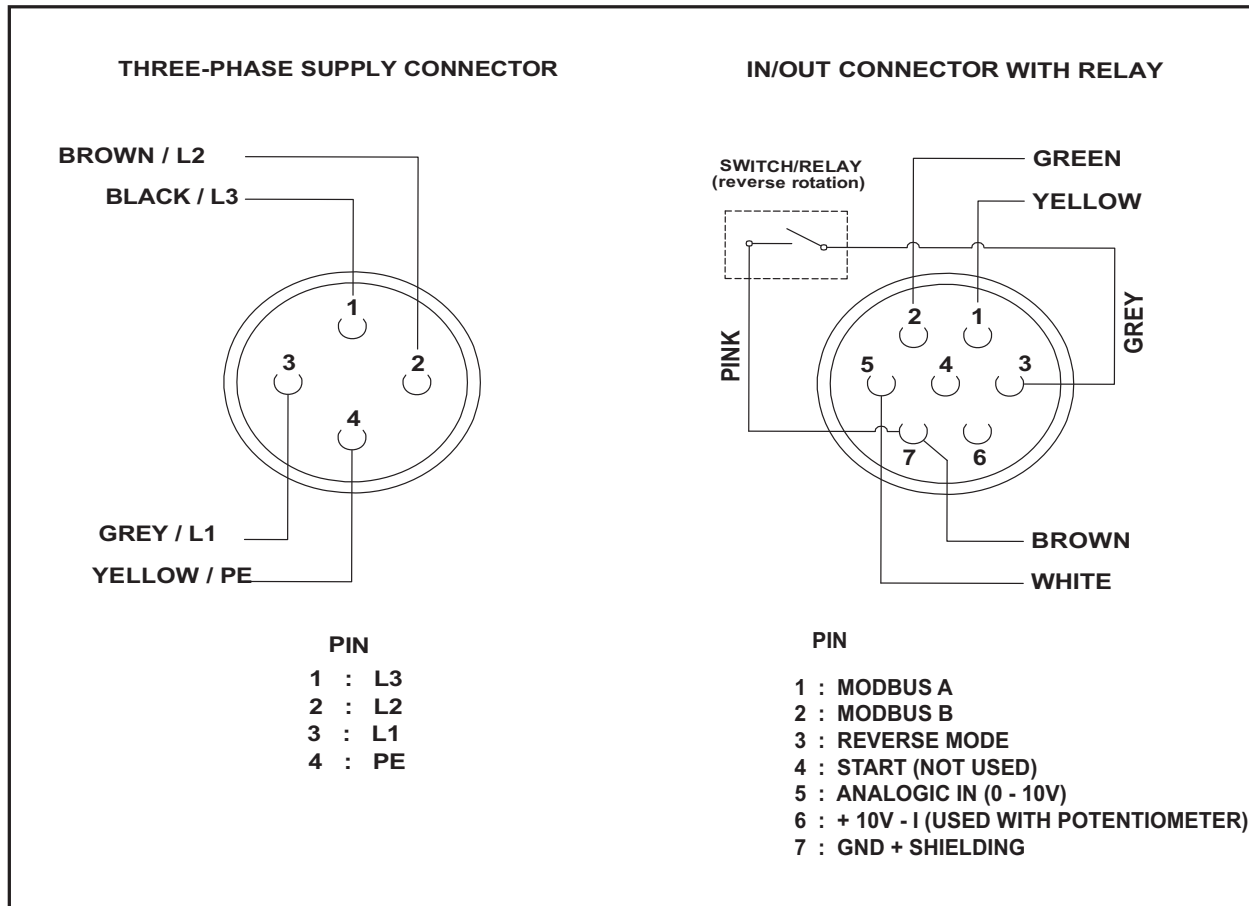
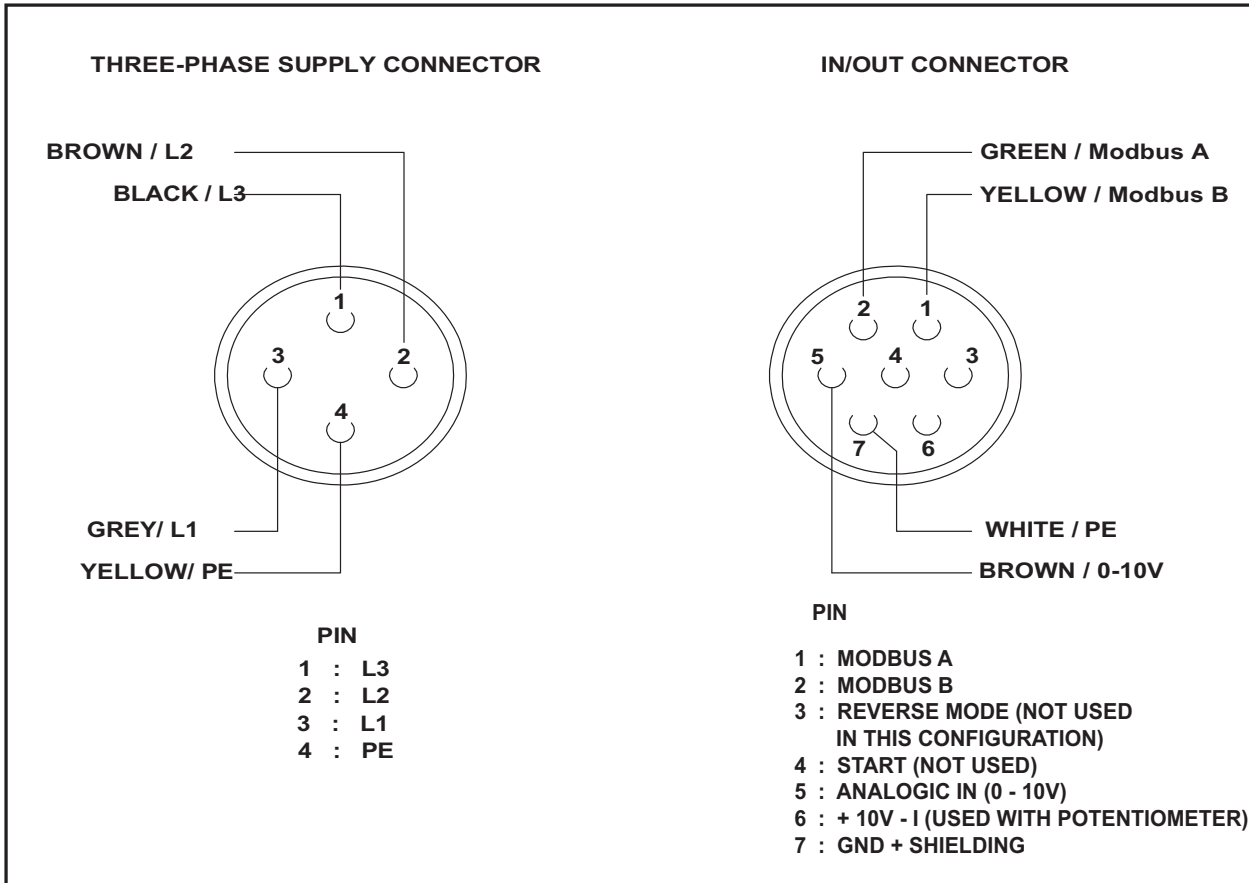

4. Connection scheme with Potenziometro

4.1 Connection with potentiometer cod. 12832

SUPPLY CONNECTOR (THREE-PHASE)

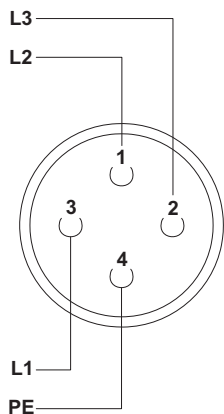

IN/OUT CONNECTOR

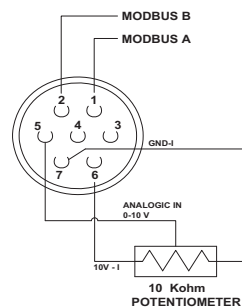

CONNECTION DETAIL

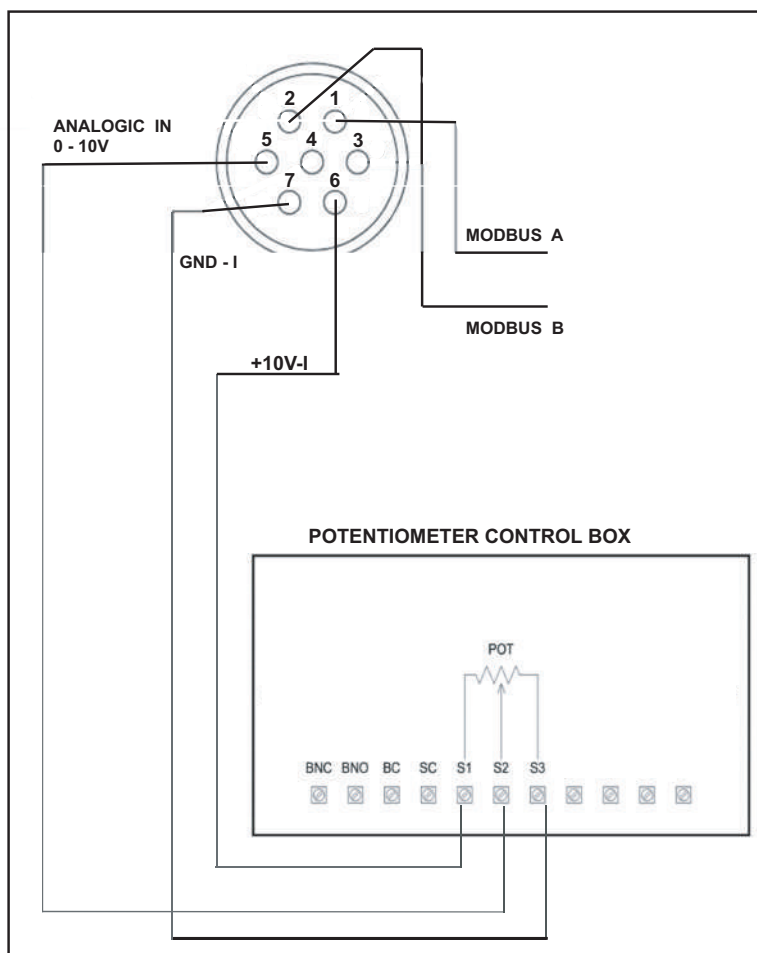

NB: It is necessary pull the A and B wires down to the control box for the Modbus connection, used for maintenance and diagnostic actions.

Electric Scheme - Option 1:
External Potentiometer
VORTICE code: 12832

4.2 Connection with potentiometer cod. 12828

SUPPLY CONNECTOR (THREE-PHASE)

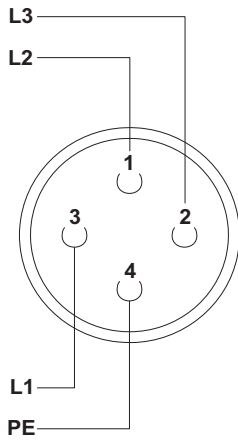

IN/OUT CONNECTOR

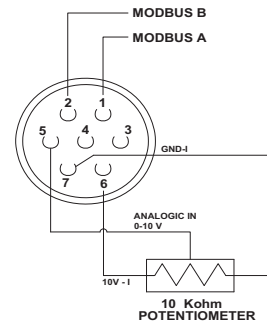

CONNECTION DETAIL

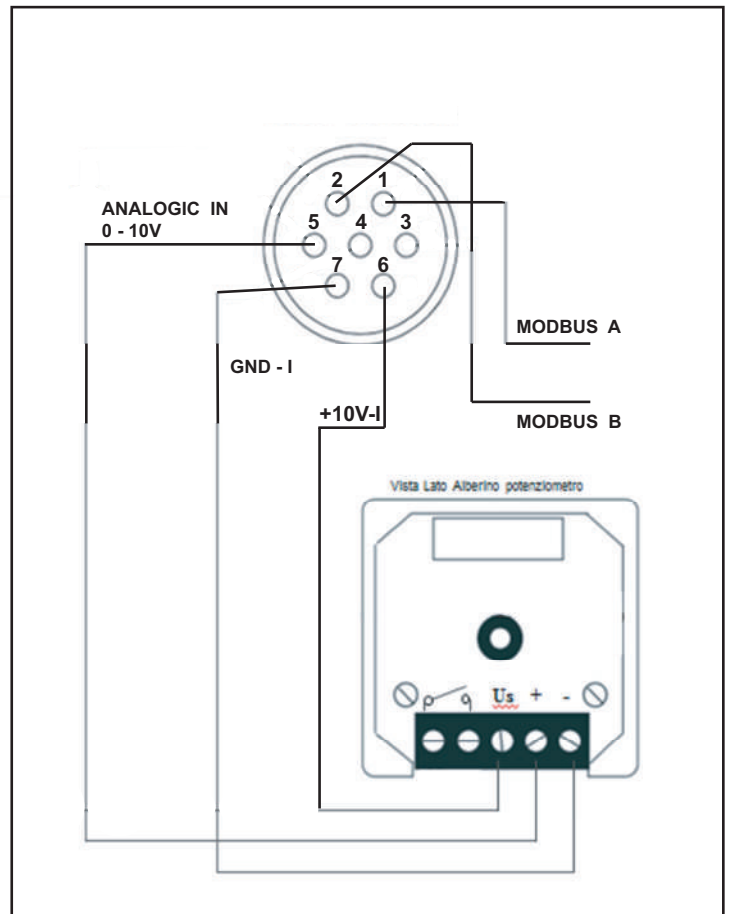

NB: It is necessary pull the A and B wires down to the control box for the Modbus connection, used for maintenance and diagnostic actions.

Electric Scheme - Option 2:
External Potentiometer with DIN box
VORTICE code: 12828

5. Connection Diagram with VORT T Control Unit

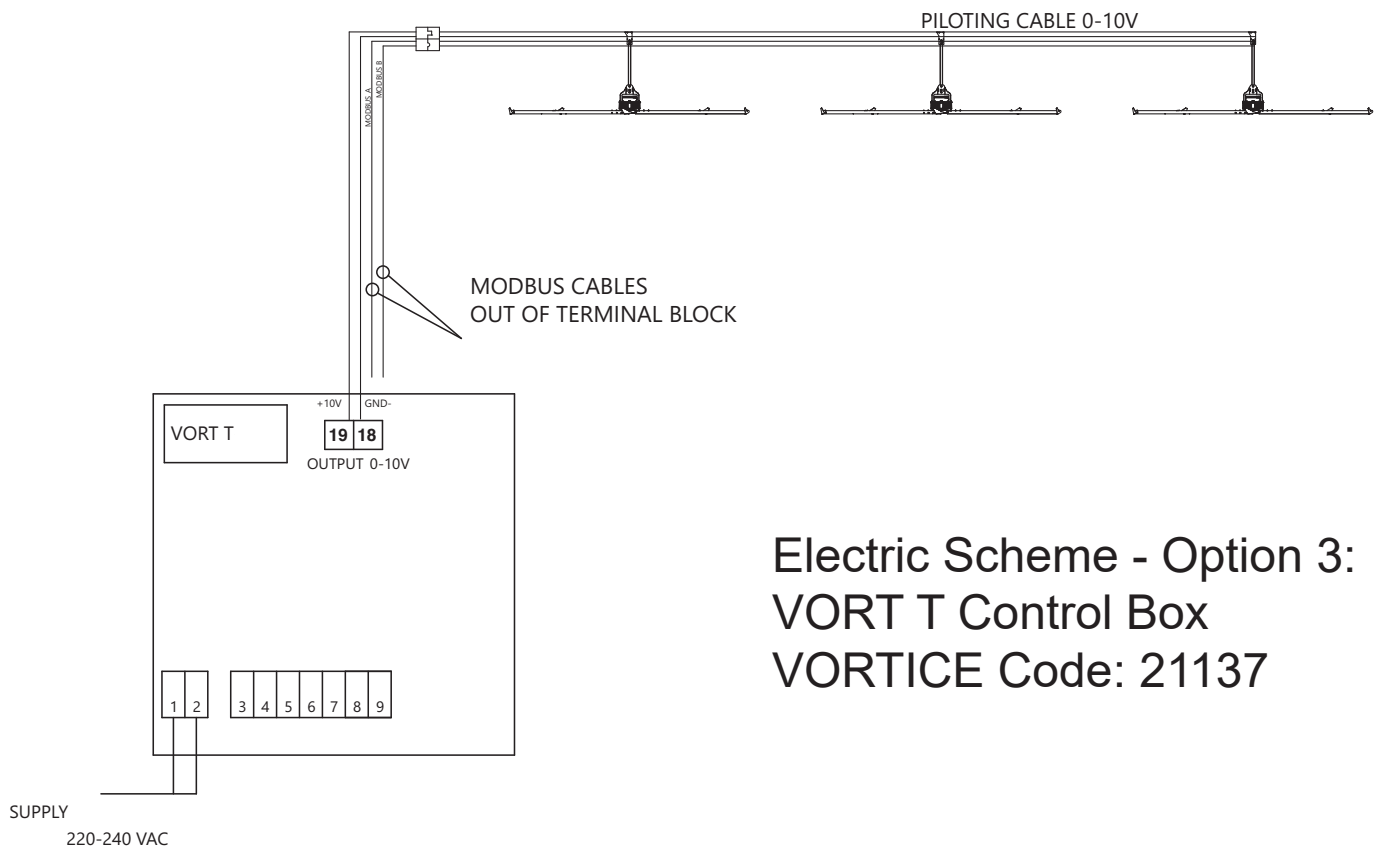

Electric Scheme - Option 3:
 VORT T Control Box
 VORTICE Code: 21137

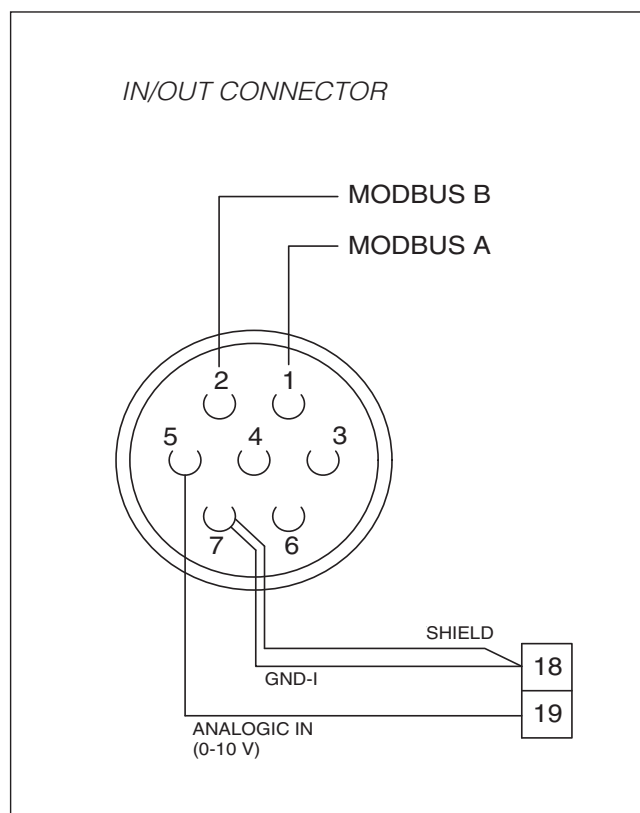

6. Connection Diagram with VORT T PLUS

Electric Scheme - Option 4:
 VORT T PLUS
 VORTICE Code: 20152

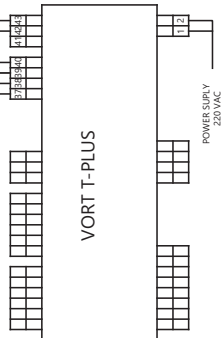
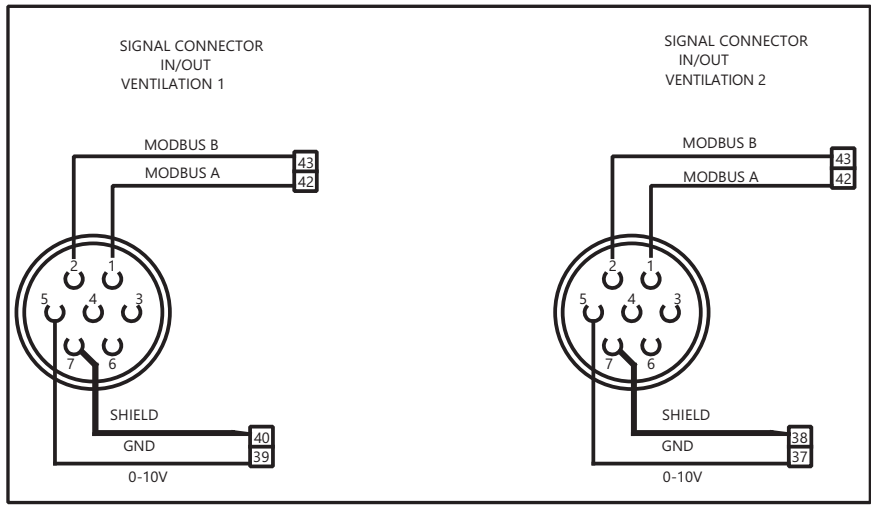
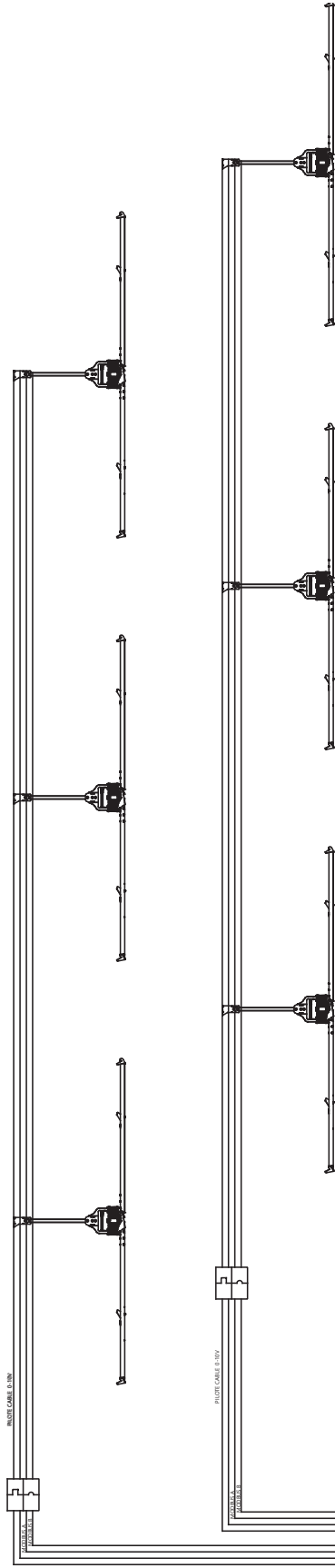

7. Connection Diagram with VORT T HCS

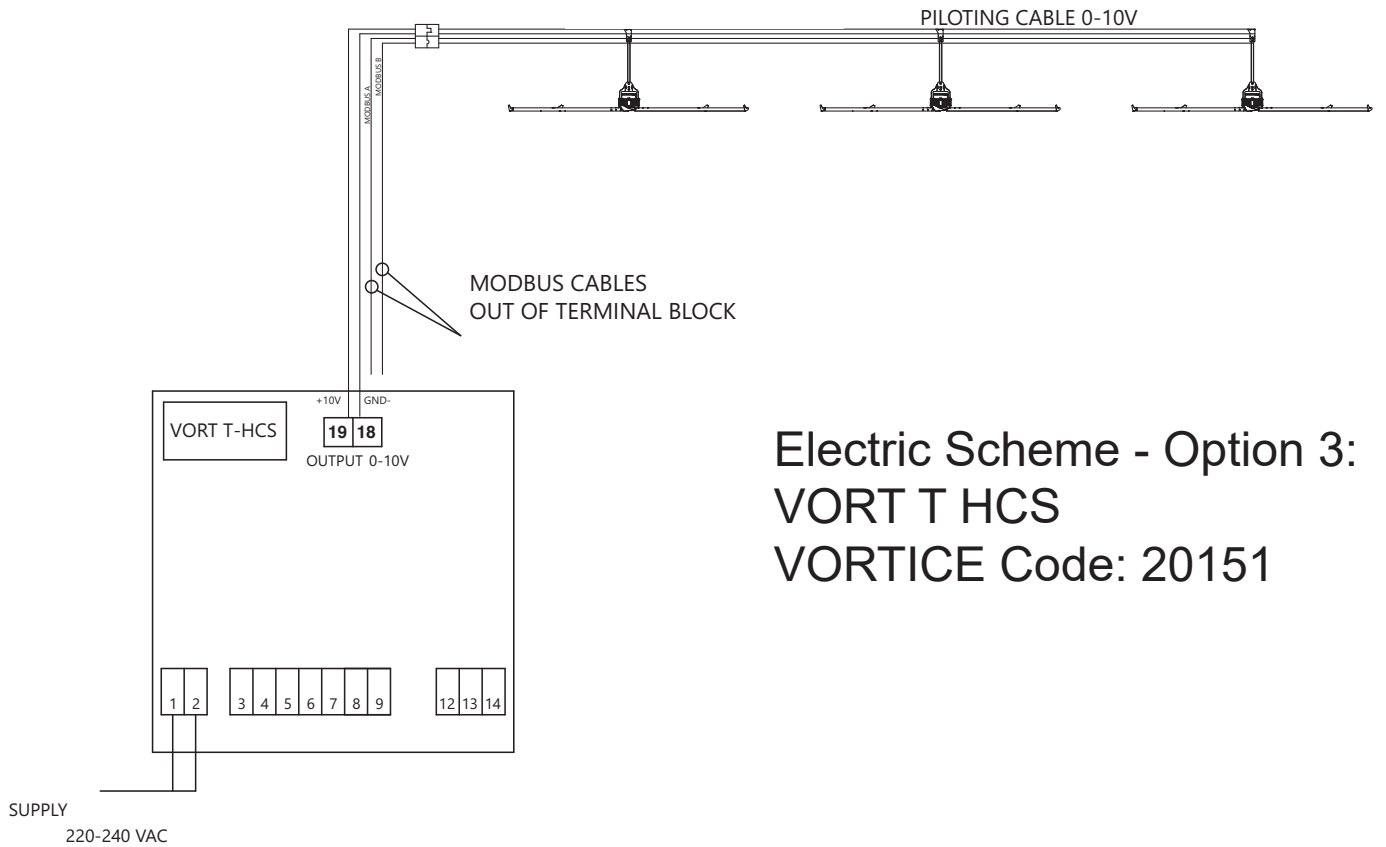

Electric Scheme - Option 3:
VORT T HCS
VORTICE Code: 20151

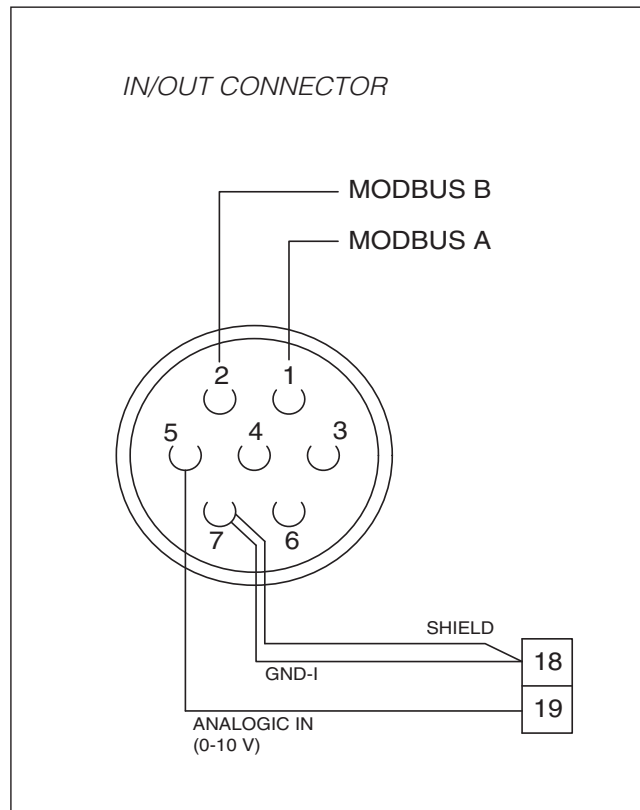

8. Connection Diagram with VORT MASTER

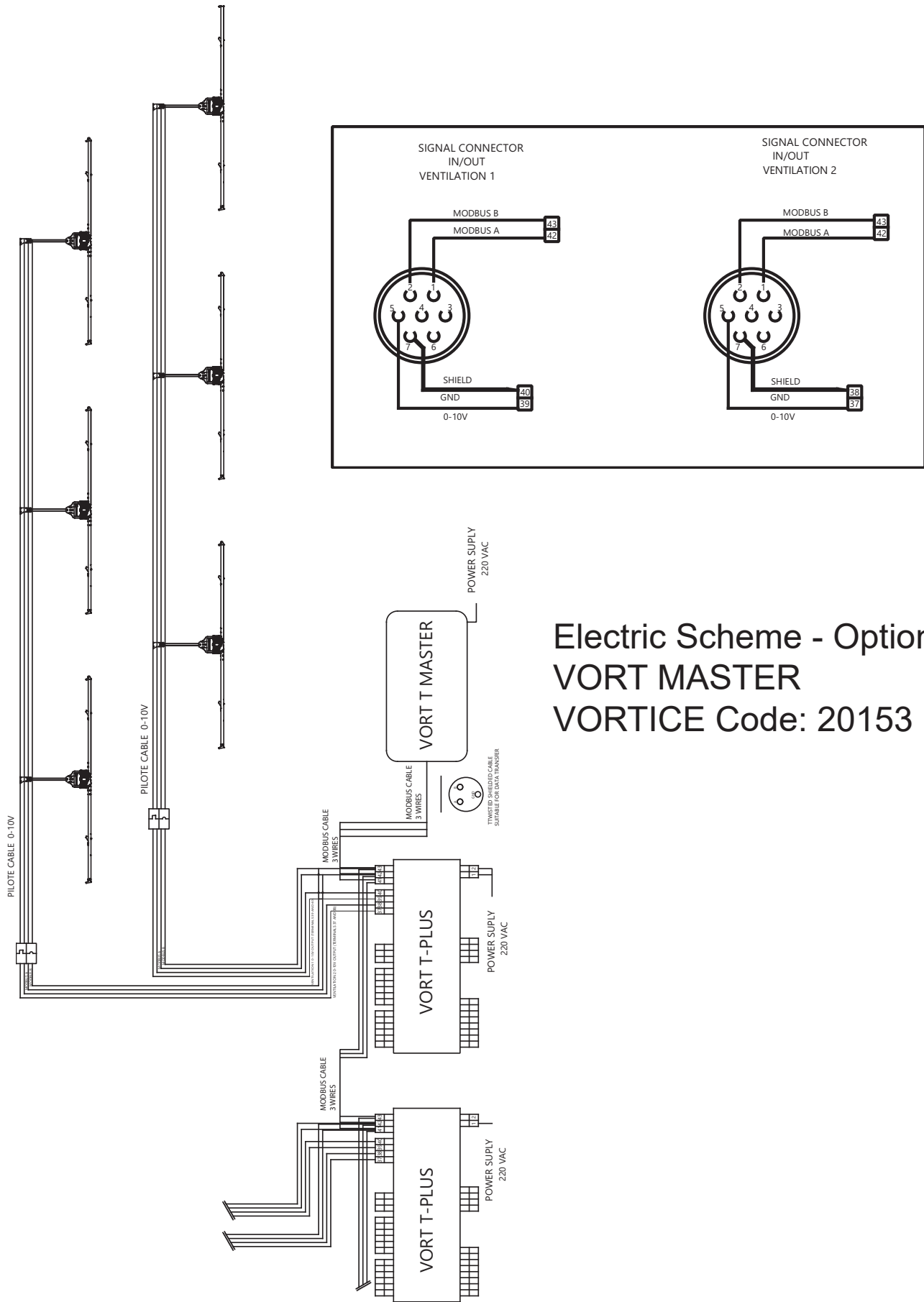

Electric Scheme - Option 3:
VORT MASTER
VORTICE Code: 20153

10. First Start-up

Once machine assembly, installation and electrical connection has been completed, power up the machine and wait about 30 seconds for it to stop its self-diagnosis of default parameters and to start rotating.

Then check that:

- there are no installation imbalances due to incorrect assembly of the components or latent their defects.
- there are no metallic noises or sounds coming from the machine itself.
- the motor diagnosis LED flashes every 2 seconds.
- the direction of rotation is clockwise, if viewed from under the destratification fan.

DISPOSAL

This product complies with Directive 2012/19/EU on the management of waste electrical and electronic equipment (WEEE).

The crossed-out wheeled bin symbol on the appliance indicates that, at the end of its life, the product should not be discarded together with household waste but must be taken to a separate collection point for electrical and electronic equipment. This will avoid negative effects on the environment and health, and will encourage correct treatment, disposal and recycling of the materials from which the product is made.



Contact the municipal authority for the location of this type of facility. Alternatively, the distributor is obliged to take back the appliance to be disposed of free of charge in exchange for the purchase of an equivalent appliance.

WARNINGS

- This appliance can be used by children no less than 8 years of age and by individuals with limited physical, sensory or mental capacities, or by inexperienced or untrained individuals, provided that they are supervised or have been instructed in safe use of the appliance and understand the associated risks. Children must not play with the appliance. Cleaning and maintenance procedures that can be undertaken by the user must not be entrusted to children, unless under supervision.
- The appliance must be installed by a professionally qualified electrician.
- A multi-pole switch must be used to install the appliance. The contact opening gap must be no less than 3 mm.

GARANZIA CONVENZIONALE - ITALIA

1. DIRITTI DEI CONSUMATORI

- 1.1 Il consumatore dispone per legge, a titolo gratuito, di rimedi per i difetti di conformità dei prodotti nei confronti del venditore che non sono pregiudicati dalla presente garanzia convenzionale aggiuntiva del produttore.
- 1.2 La presente garanzia convenzionale offerta da VORTICE S.p.A., con sede in Strada Cerca 2, Frazione di Zoate, 20067, Tribiano (MI) non pregiudica, pertanto, i diritti dei consumatori che sono previsti dalla Direttiva (UE) 2019/771 (c.d. "direttiva garanzia") e dalla relativa legislazione nazionale di attuazione e recepimento nei paesi membri della UE (in Italia v. Codice del Consumo D.lgs. 206/2005).

2. DURATA DELLA GARANZIA CONVENZIONALE

- 2.1 VORTICE S.p.A. offre la presente garanzia convenzionale su tutti i propri prodotti per il periodo di 2 anni.
- 2.2 Per i soli prodotti appartenenti alla famiglia Nordik HVLS Superblade, la garanzia convenzionale offerta da VORTICE S.p.A. ha durata di 5 anni per le parti meccaniche ed il motore e di 3 anni per l'inverter.
- 2.3 La garanzia convenzionale decorre, in tutti i casi previsti, dalla data di acquisto dei prodotti che deve essere comprovata dall'acquirente per mezzo di idoneo documento fiscale rilasciato dal venditore (scontrino o fattura), che deve indicare la data di acquisto ed il modello di prodotto acquistato.

3. CONDIZIONI DELLA GARANZIA CONVENZIONALE - ESCLUSIONI

- 3.1 Nel periodo di garanzia previsto, VORTICE S.p.A. si impegna, attraverso la propria rete di assistenza e dopo aver effettuato le opportune valutazioni tecniche, a riparare o a sostituire il prodotto o le parti del prodotto stesso che risultino affette da difetti originari di fabbricazione. I rimedi della sostituzione o della riparazione sono posti in essere senza spese per il soggetto qualificabile come Consumatore a norma di legge.
- 3.2 Sono esclusi dalla garanzia convenzionale tutti i difetti e/o i guasti derivanti da:
 - a) normale usura del prodotto o dei componenti del prodotto medesimo;
 - b) utilizzo non corretto o improprio del prodotto, in difformità rispetto alle istruzioni ed alle avvertenze fornite da VORTICE S.p.A. unitamente al prodotto medesimo;
 - c) installazione del prodotto in difformità rispetto alle istruzioni fornite da VORTICE S.p.A. o comunque in difformità rispetto alla regola dell'arte vigente in materia di installazione di prodotti elettrici;
 - d) errato allacciamento alla rete di alimentazione elettrica o da tensione di alimentazione diversa da quella prevista per l'apparecchio, ovvero diversa dal limite stabilito dalla norma CEI (+/- 10% del valore nominale);
 - e) manutenzione errata e/o carente e/o effettuata in difformità rispetto alle istruzioni fornite da VORTICE S.p.A.;
 - f) manutenzione e/o altri interventi effettuati da personale non abilitato o da soggetti non autorizzati da VORTICE S.p.A.;
 - g) guasti derivanti da errate condizioni di trasporto o di magazzino del prodotto non imputabili a VORTICE S.p.A.;
 - h) modifica del prodotto da parte di soggetto diverso da VORTICE S.p.A. o non espressamente autorizzato per iscritto da quest'ultimo.

4. PROCEDURA DI VALIDAZIONE DELLA GARANZIA CONVENZIONALE - INTERVENTI

- 4.1 Per fare valere la garanzia convenzionale il consumatore dovrà inviare il documento fiscale comprovante la data di acquisto unitamente alla presente pagina, contenente l'indicazione del numero di matricola del prodotto, agli indirizzi indicati nel successivo paragrafo 4.2.
 - 4.2 Modalità di esecuzione degli interventi e indirizzi e-mail di contatto:
 - per prodotti ATEX: gli interventi saranno eseguiti presso la Sede VORTICE S.p.A.; scrivere un'e-mail all'indirizzo postvendita@vortice.it o contattare il numero 0290699395;
 - per i prodotti Climatizzazione: gli interventi saranno eseguiti presso il domicilio del cliente per i prodotti che necessitano di installazione e per quelli che non sono facilmente trasportabili, oppure in tutti gli altri casi presso uno dei Centri di Assistenza Tecnica autorizzati da VORTICE S.p.A.; scrivere un'e-mail all'indirizzo postvendita@vortice.it o contattare il numero 0290699395;
 - per tutti gli altri prodotti: gli interventi saranno eseguiti presso uno dei Centri di Assistenza Tecnica autorizzati da VORTICE S.p.A., identificabili contattando il numero verde 800.555.777.
- La prestazione eseguita in garanzia non prolunga il periodo di validità della garanzia stessa. Pertanto, in caso di sostituzione del prodotto o di un suo componente, sul bene o sul singolo componente fornito in sostituzione non decorre un nuovo periodo di garanzia a partire dal momento dell'effettuazione dell'intervento, in quanto si deve tener conto esclusivamente della data di acquisto del prodotto originario.

5. ESTENSIONE TERRITORIALE

La presente garanzia è valida su tutto il territorio italiano.

CONF.	COLL.
-------	-------

WARRANTY - OTHER COUNTRIES

The consumer has by law, free of charge, the legal guarantee of conformity with the seller, as described in Directive (EU) 2019/771 in force since January 1, 2022. In EU member countries also refer to local regulations.

PAÍSES DE AMÉRICA LATINA GARANTÍA ESTÁNDAR VORTICE LATAM S.A.

1. DERECHOS DEL CONSUMIDOR

- 1.1 El consumidor dispone por ley, de forma gratuita, recursos por la falta de conformidad de los productos frente al vendedor que no se ven afectados por esta garantía estándar adicional del fabricante.

2. DURACIÓN DE LA GARANTÍA ESTÁNDAR

- 2.1 VORTICE LATAM S. A. ofrece esta garantía estándar por un período de 2 años.
- 2.2 Para productos de la familia Nordik HVLS Superblade, la garantía estándar ofrecida por VORTICE LATAM S.A. tiene una duración de 5 años para las partes mecánicas y motor y de 3 años para el inversor.
- 2.3 La garantía estándar comienza, en todos los casos previstos, a partir de la fecha de compra de los productos que deberá ser acreditada por el comprador mediante un documento fiscal emitido por el vendedor (recibo o factura), que debe indicar la fecha de compra y el modelo del producto adquirido.

3. CONDICIONES DE LA GARANTÍA ESTÁNDAR - EXCLUSIONES

- 3.1 Durante el período de garantía, VORTICE LATAM S. A. se compromete, a través de su red de asistencia y previa realización de las oportunas valoraciones técnicas, a reparar o reemplazar el producto o partes del producto que estén afectadas por defectos de fabricación originales. La sustitución o las reparaciones se realizan sin costo adicional para la persona calificada como consumidor según la ley.
- 3.2 Quedan excluidos de la garantía estándar todos los defectos y/o fallas derivados de:
- a) desgaste normal del producto o de sus componentes.
 - b) uso incorrecto o inadecuado del producto, contrario a las instrucciones y advertencias proporcionadas por VORTICE LATAM S. A. junto con el producto mismo.
 - c) instalación del producto no conforme a las instrucciones proporcionadas por VORTICE LATAM S.A. o en cualquier caso no conforme a la normativa vigente en instalación de productos eléctricos.
 - d) conexión incorrecta a la red de alimentación eléctrica o a una tensión de alimentación diferente de la prevista para el equipo.
 - e) mantenimiento incorrecto y/o deficiente y/o realizado de forma contraria a las instrucciones proporcionadas por VORTICE LATAM S. A.
 - f) mantenimiento y/u otras intervenciones realizadas por personal no autorizado por VORTICE LATAM S. A.
 - g) fallas derivadas de condiciones incorrectas de transporte o almacenamiento del producto no imputables a VORTICE LATAM S. A.
 - h) modificación del producto por persona ajena a VORTICE S. p. A. o no autorizada expresamente por escrito por éste.

4. PROCEDIMIENTO DE VALIDACIÓN DE LA GARANTÍA ESTÁNDAR – REPARACIONES

- 4.1 Para hacer efectiva la garantía estándar, el consumidor deberá enviar el documento fiscal que acredite la fecha de compra junto con esta hoja a VORTICE LATAM S.A., indicando el número de serie del producto.
- 4.2 Las intervenciones se realizarán en uno de los Centros de Asistencia Técnica autorizados por VORTICE LATAM S.A. El servicio realizado bajo garantía no extiende el período de validez de la garantía. Por lo tanto, en caso de sustitución del producto o de uno de sus componentes, no se inicia un nuevo período de garantía sobre el bien o sobre el componente individual suministrado como sustitución a partir del momento en que se realiza la intervención, ya que sólo debe indicarse la fecha teniendo en cuenta la compra del producto original.
- Procedimiento para la realización de las intervenciones y direcciones de correo electrónico de contacto:
- para productos ATEX: las reparaciones se realizarán en la sede de VORTICE LATAM S. A.; Escriba un email al correo info@vortice-latam.com o comuníquese al número + (506) 87346996;
 - para los productos que requieren instalación y para los que no son fácilmente transportables las reparaciones se realizarán en el domicilio del cliente; Escriba un email a info@vortice-latam.com o comuníquese al número + (506) 87346996;
 - Para todos los demás productos: las reparaciones se realizarán en uno de los Centros de Asistencia Técnica Autorizado por VORTICE LATAM S. A. identificable comunicándose con el número + (506) 87346996.

5. EXTENSIÓN TERRITORIAL

Esta garantía es válida en todos los países de América Latina donde se vende este producto.

GARANTÍA - OTROS PAÍSES

El consumidor tiene por ley, de forma gratuita, la garantía legal de conformidad con el vendedor, tal y como se describe en la Directiva (UE) 2019/771 en vigor desde el 1 de enero de 2022. En los países miembros de la UE también consulte las normativas locales.



VORTICE S.p.A. si riserva il diritto di apportare tutte le varianti migliorative ai prodotti in corso di vendita.
VORTICE S.p.A. reserves the right to make improvements to products at any time and without prior notice.
VORTICE S.p.A. se réserve le droit d'apporter toutes les variations afin d'améliorer ses produits en cours de commercialisation.
VORTICE S.p.A. behält sich vor, alle eventuellen Verbesserungsänderungen an den Produkten des Verkaufsangebots vorzunehmen.
VORTICE S.p.A. se reserva el derecho a hacer cambios en los productos para su mejora en cualquier momento sin previo aviso.
VORTICE S.p.A. 公司 股份有限公司 保留在产品销售期间进行产品改良的权利。

VORTICE GROUP COMPANIES

VORTICE S.p.A.
Strada Cerca, 2 - frazione di Zoate
20067 - Tribiano (MI)
Tel. +39 02-90.69.91
ITALY
vortice.com
postvendita@vortice-italy.com

VORTICE INDUSTRIAL Srl
Via B. Brugnoli, 3
37063 - Isola della Scala (VR)
Tel. +39 045 6631042
ITALY
vorticeindustrial.com
info@vorticeindustrial.com

VORTICE VENTILATION SYSTEM (CHANGZHOU) CO.LTD
Building 19, No.388 West Huanghe Road, Xinbei District,
Changzhou, Jiangsu Province CAP:213000
CHINA
vortice-china.com
vortice@vortice-china.com

VORTICE LIMITED
Beeches House-Eastern Avenue
Burton on Trent - DE 13 0BB
Tel. +44 1283-49.29.49
UNITED KINGDOM
vortice.ltd.uk
sales@vortice.ltd.uk

VORTICE LATAM S.A.
Bodega #6
Zona Franca BES Alajuela - Alajuela 20101
Tel. (+506) 2201 6934
COSTA RICA
vortice-latam.com
info@vortice-latam.com

CASALS VENTILACIÓN INDUSTRIAL IND., S.L.
Ctra. Camprodon, s/n
17860 - Sant Joan de les Abadesses (Girona)
SPAIN
casals.com
ventilacion@casals.com